

CSA-R 403.940.MF/DALI

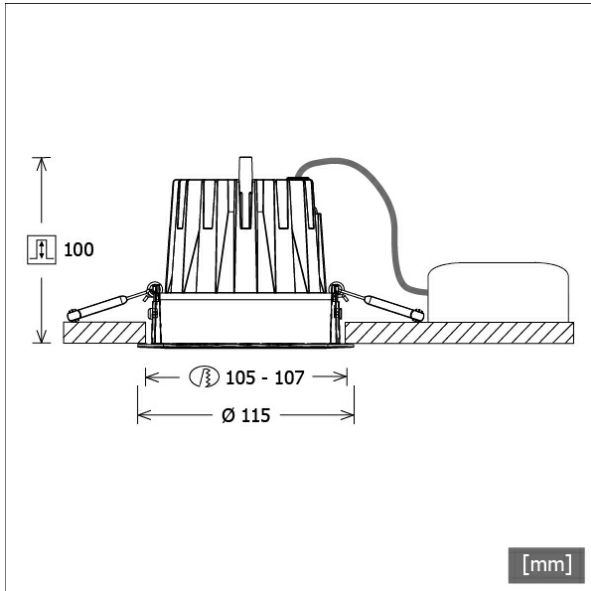

Colours	Article no.	EAN
silver	668168	4043544798275
black	668169	4043544798282
white	668170	4043544798299



Description

- recessed downlight with wide range of applications
- outstanding ease of maintenance
- no UV and thermal emissions
- innovative thermal management with passive cooling (heat sink made from die-cast aluminium)
- specular aluminium reflector with precise symmetrical beam characteristic for high luminous efficiency and glare-free lighting
- front ring made from die-cast aluminium with filigree black polycarbonate inner ring for additional glare control
- tool-free ceiling mounting via quick-action clamping springs (automatic adjustment of the ceiling thickness)
- luminaire and ballast permanently connected via cable (length: 500 mm), ballast ready for mains connection
- ballast (LED converter DALI, dimmable) included (external placement)

Standard options



Special options



Lighting data / Norms

Lamps	LED Spot / CRI 90 / 4000 K
EPREL light sources	1115635
Lifetime	L90 B50 50.000 h L80 B50 100.000 h L80 B20 50.000 h
System power	27.1 W
Luminaire luminous flux	3500 lm
System efficiency	129.15 lm/W
Module efficiency	139.54 lm/W
UGR class	≤22
Beam range	Medium Flood
Beam angle	23°
Supply voltage	220 - 240 V / 50 - 60 Hz
Protection class	II
Type of protection	IP20

Dimensions / Weights

Outer diameter	115 mm
Height	102 mm
Cut-out (Ø)	105 - 107 mm
Ceiling thickness	3.0 - 26.0 mm
Recessed depth	100 mm
Net weight	0.48 kg
Gross weight	0.54 kg

CSA-R 403.940.MF/DALI

CSA-R 403.940.MF/DALI

CSA 40 Generation 2 (1xLED 27W 940/4000K 3500lm 23°)

C0/C180 cd / 1000 lm

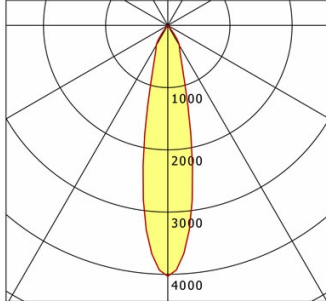

	C0	C90	C180	C270
0°	4033	4033	4033	4033
15°	1167	1167	1167	1167
30°	371	371	371	371
45°	13	13	13	13
60°	5	5	5	5
75°	1	1	1	1
90°	0	0	0	0
cd / 1000 lm				

Offset [m] Cone width [m] Illuminance [lx]

Offset [m]	Cone width [m]	Illuminance [lx]
3.0	1.18	1568.3
6.0	2.35	392.1
9.0	3.53	174.3
12.0	4.71	98.0
15.0	5.89	62.7

η	LED
Efficiency	130 lm/W
Direct/Indirect	↓ 100% / ↑ 0%
System Power	27 W
UGR	X=4H, Y=8H
Reflection factors	70/50/20
UGR C0/C180	19.6
UGR C90/C270	19.6
CIE Flux Codes	98 100 100 100 100
Ra/CRI	>90

LTS

Accessories



ZB-OR DONGLE
Organic Response IR dongle kit



ZB-OR GATEWAY
Organic Response IoT Gateway Cascade Series



ZB-OR-R SENSOR
Organic Response sensor for recessed mounting