

FLIR 200.2030.25/DALI

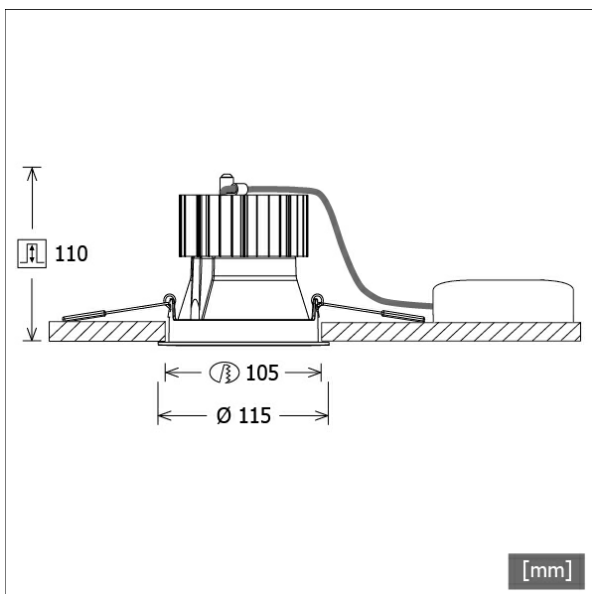

Colours	Article no.	EAN
black	641750	4043544472960
silver	641751	4043544472977
white	641752	4043544472984



Description

- recessed spotlight with optical design variants and wide range of applications
- light-head pivots through 20°
- outstanding ease of maintenance
- no UV and thermal emissions
- thermal management with passive cooling (heat sink made from aluminium)
- high performance specular aluminium reflector with precise symmetrical beam characteristic for highest luminous efficiency and best glare-free lighting
- front/recessed ring made from die-cast zinc with clear light effect ring (other decor/light effect rings and deco glasses are available as options)
- tool-free ceiling mounting via quick-action clamping springs (automatic adjustment of the ceiling thickness)
- luminaire and ballast permanently connected via cable (length: 500 mm), ballast ready for mains connection
- ballast (LED converter DALI, dimmable) included (external placement)

Standard options

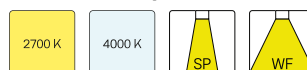

Special options



Lighting data / Norms

Lamps	LED Spot / CRI 80 / 3000 K
EPREL light sources	848117
Lifetime	L90 B50 50.000 h L80 B50 100.000 h L80 B20 50.000 h
System power	27.0 W
Luminaire luminous flux	max. 2960 lm
System efficiency	109.62 lm/W
Module efficiency	156.64 lm/W
UGR class	≤28
Beam range	Medium Flood
Beam angle	29°
Supply voltage	220 - 240 V / 50 - 60 Hz
Protection class	II
Type of protection	IP20

Dimensions / Weights

Outer diameter	115 mm
Height	112 mm
Cut-out (Ø)	105 mm
Ceiling thickness	1.0 - 25.0 mm
Recessed depth	110 mm
Net weight	0.93 kg
Gross weight	1.01 kg

FLIR 200.2030.25/DALI

FLIR 200.2030.25/DALI

Flixx 200 Round (FLIRZ 200.05, 1xLED 27W 830/3000K 2960lm 29°)

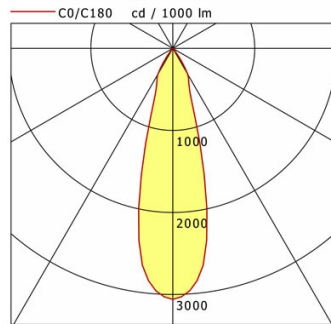

	C0	C90	C180	C270
0°	3059	3059	3059	3059
15°	1386	1386	1386	1386
30°	362	362	362	362
45°	16	16	16	16
60°	11	11	11	11
75°	5	5	5	5
90°	0	0	0	0

cd / 1000 lm

Offset [m]	Cone width [m]	Illuminance [lx]
3.0	1.53	1006.1
6.0	3.06	251.5
9.0	4.59	111.8
12.0	6.12	62.9
15.0	7.65	40.2

η	LED
Efficiency	110 lm/W
Direct/Indirect	↓ 100% / ↑ 0%
System Power	27 W
UGR	X=4H, Y=8H
Reflection factors	70/50/20
UGR C0/C180	19.6
UGR C90/C270	19.6
CIE Flux Codes	96 98 100 100 100
Ra/CRI	>80

LTS

FLIR 200.2030.25/DALI

Flixx 200 Round (FLIRZ 200.24, 1xLED 27W 830/3000K 2790lm 29°)

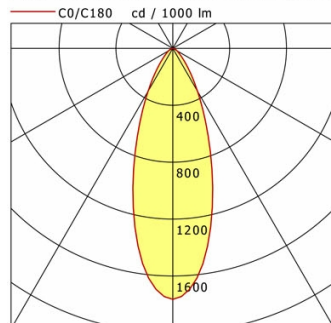

	C0	C90	C180	C270
0°	1764	1764	1764	1764
15°	1084	1084	1084	1084
30°	348	348	348	348
45°	95	95	95	95
60°	35	35	35	35
75°	14	14	14	14
90°	0	0	0	0

cd / 1000 lm

Offset [m]	Cone width [m]	Illuminance [lx]
3.0	1.97	546.8
6.0	3.94	136.7
9.0	5.91	60.8
12.0	7.88	34.2
15.0	9.85	21.9

η	LED
Efficiency	103 lm/W
Direct/Indirect	↓ 100% / ↑ 0%
System Power	27 W
UGR	X=4H, Y=8H
Reflection factors	70/50/20
UGR C0/C180	25.6
UGR C90/C270	25.6
CIE Flux Codes	85 95 99 100 100
Ra/CRI	>80

LTS

FLIR 200.2030.25/DALI

Flixx 200 Round (FLIRZ 200.25, 1xLED 27W 830/3000K 2880lm 29°)

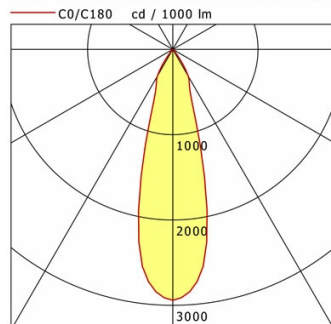

	C0	C90	C180	C270
0°	2942	2942	2942	2942
15°	1350	1350	1350	1350
30°	366	366	366	366
45°	19	19	19	19
60°	14	14	14	14
75°	4	4	4	4
90°	0	0	0	0

cd / 1000 lm

Offset [m]	Cone width [m]	Illuminance [lx]
3.0	1.54	941.4
6.0	3.08	235.3
9.0	4.62	104.6
12.0	6.16	58.8
15.0	7.70	37.7

η	LED
Efficiency	107 lm/W
Direct/Indirect	↓ 100% / ↑ 0%
System Power	27 W
UGR	X=4H, Y=8H
Reflection factors	70/50/20
UGR C0/C180	19.9
UGR C90/C270	19.9
CIE Flux Codes	95 99 100 100 100
Ra/CRI	>80

LTS

FLIRZ 200.2030.25/DALI

Accessories



FLIRZ 200.01
decorative ring black



FLIRZ 200.02
decorative ring silver



FLIRZ 200.03
decorative ring white



FLIRZ 200.04
light effect ring opal



FLIRZ 200.05
light effect ring clear



FLIRZ 200.06
light effect ring red matt



FLIRZ 200.07
light effect ring yellow matt



FLIRZ 200.08
light effect ring blue matt



FLIRZ 200.16
light effect ring red translucent



FLIRZ 200.17
light effect ring yellow translucent



FLIRZ 200.18
light effect ring blue translucent

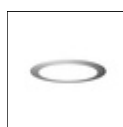

FLIRZ 200.24
decorative glass opal



FLIRZ 200.25
decorative glass clear



ZB-OR DONGLE
Organic Response IR dongle kit



ZB-OR GATEWAY
Organic Response IoT Gateway Cascade Series



ZB-OR-R SENSOR
Organic Response sensor for recessed mounting