

LK-L 060.10830.1405.U19/DALI



Description

- light-insert with integrated LED strips for 360° glare-free workplace lighting (UGR < 19)
- reflector made from traffic white painted aluminium sheet
- anti-glare collimators made from polycarbonate
- no UV and thermal emissions
- almost all strip light lengths can be realised
- 5-pole through-wiring kit included
- pMMA matt foil for uniform light distribution
- tool-free snapping into Lichtkanal profile via mounting springs
- 5-pole terminal block, pre-fabricated for through-wiring
- ballast (LED converter DALI, dimmable) integrated

Notes

Use only in conjunction with nanoOptix light-directing foils "deep beam" (STRL-LK060-Z 690.DB), "batwing and wide beam" (STRL-LK060-Z 690.BW-WB) and "wallwasher" (STRL-LK060-Z 690.WW). The linear thermal expansion of the aluminium profile is about 0.3 mm per meter at dT = 10 Kelvin.

Colours	Article no.	EAN
	667943	4043544795908

Standard options



Lighting data / Norms

Lamps	LED linear / CRI 80 / 3000 K
Lifetime	L90 B50 50.000 h L80 B50 100.000 h L80 B20 50.000 h
System power	15.1 W
Luminaire luminous flux	max. 2230 lm
System efficiency	147.68 lm/W
Module efficiency	193.00 lm/W
UGR class	≤19
Supply voltage	220 - 240 V / 50 - 60 Hz
Protection class	I

Dimensions / Weights

Length	1405 mm
Width	50 mm
Height	37 mm
Net weight	1.11 kg
Gross weight	1.17 kg

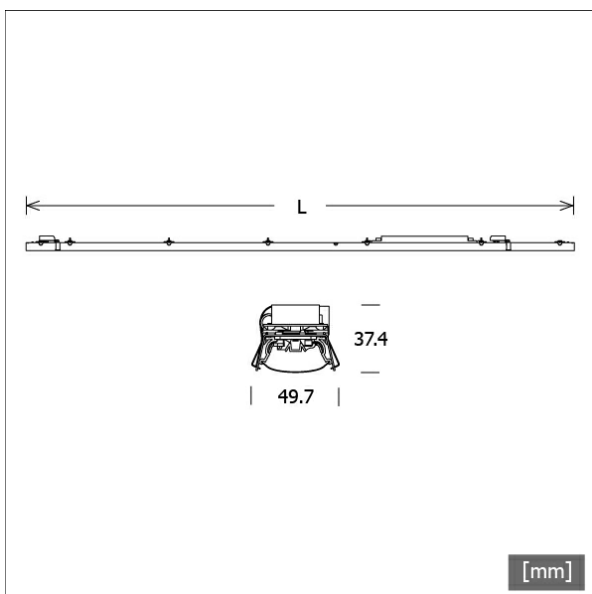

LK-L 060.10830.1405.U19/DALI

LK-L 060.10830.1405.U19/DALI

Lichtkanal 060 | Light-Insert (Deep Beam nanoOptix, 1xLED 15W 830/3000K 2230lm)

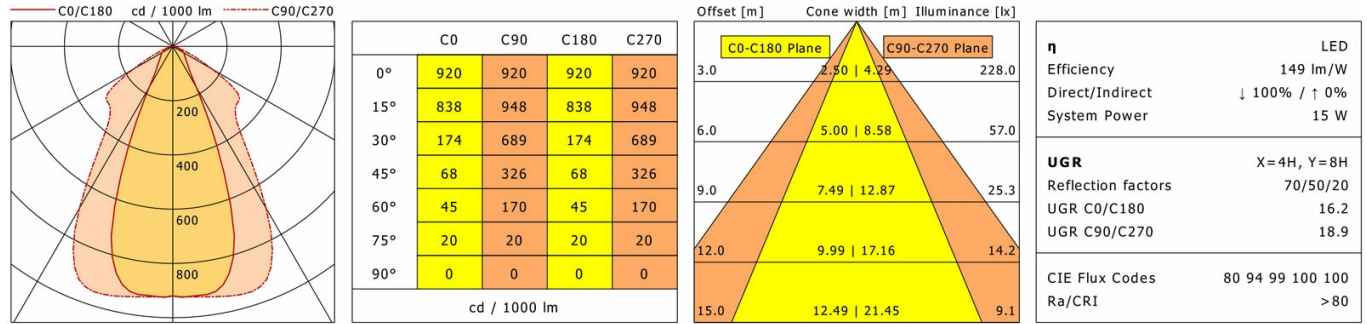

LTS

LK-L 060.10830.1405.U19/DALI

Lichtkanal 060 | Light-Insert (Batwing/Wide Beam nanoOptix, 1xLED 15W 830/3000K 2200lm)

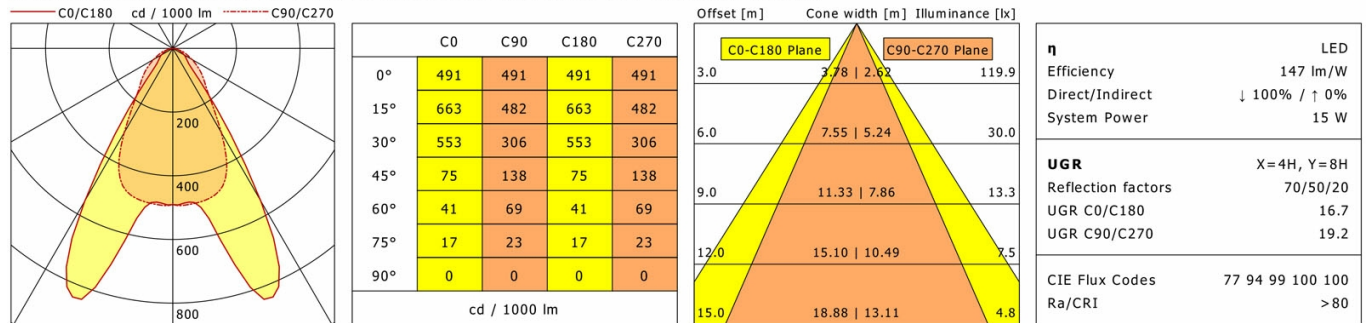

LTS

LK-L 060.10830.1405.U19/DALI

Lichtkanal 060 | Light-Insert (Wallwasher nanoOptix, 1xLED 15W 830/3000K 2140lm)

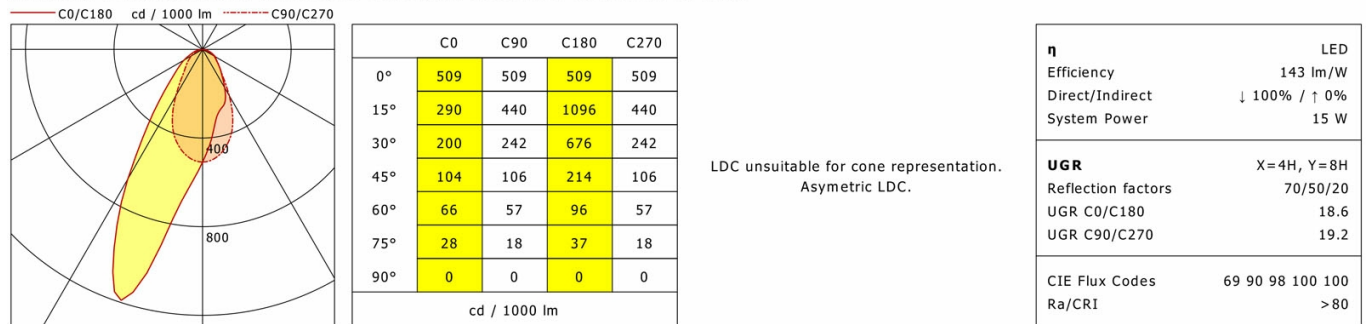

LTS