

CSALP 50.1027.50



Description

- recessed spotlight with conical light-head
- suitable for lighting of vertical surfaces
- luminaire rotates through 350° and light-head pivots out through 35°
- outstanding ease of maintenance
- no UV and thermal emissions
- thermal management with passive cooling (heat sink made from aluminium)
- specular aluminium reflector with precise symmetrical beam characteristic for high luminous efficiency and glare-free lighting
- front/recessed ring and light-head made from die-cast zinc
- clear safety glass
- tool-free ceiling mounting via quick-action clamping springs (automatic adjustment of the ceiling thickness)
- luminaire and ballast permanently connected via cable (length: 500 mm), ballast ready for mains connection
- ballast (LED converter) included (external placement)

Standard options



Special options



Colours	Article no.	EAN
black	643399	4043544496058
silver	643400	4043544496065
white	643401	4043544496072

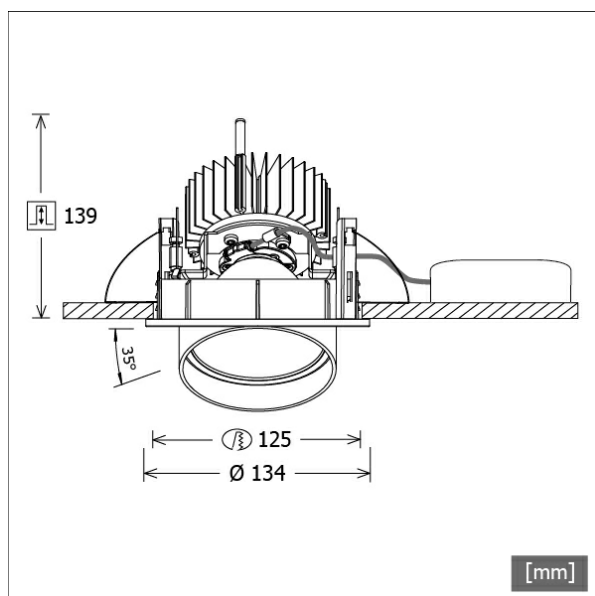

Lighting data / Norms

Lamps	LED Spot / CRI 80 / 2700 K
EPREL light sources	848120
Lifetime	L90 B50 50.000 h L80 B50 100.000 h L80 B20 50.000 h
System power	14.0 W
Luminaire luminous flux	1300 lm
System efficiency	92.85 lm/W
Module efficiency	127.18 lm/W
UGR class	≤19
Beam angle	50°
Supply voltage	220 - 240 V / 50 - 60 Hz
Protection class	II
Type of protection	IP20

Dimensions / Weights

Outer diameter	134 mm
Height	144 mm
Cut-out (Ø)	125 mm
Ceiling thickness	1.0 - 25.0 mm
Recessed depth	139 mm
Net weight	1.17 kg
Gross weight	1.23 kg



CSALP 50.1027.50

CSA 50 (1xLED 14W 827/2700K 1300lm 50 °)

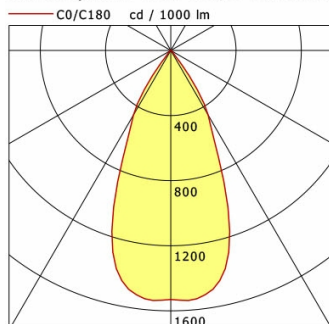

	C0	C90	C180	C270
0°	1530	1530	1530	1530
15°	1339	1339	1339	1339
30°	457	457	457	457
45°	18	18	18	18
60°	6	6	6	6
75°	5	5	5	5
90°	0	0	0	0
cd / 1000 lm				

Offset [m]	Cone width [m]	Illuminance [lx]
3.0	2.59	221.0
6.0	5.19	55.3
9.0	7.78	24.6
12.0	10.38	13.8
15.0	12.97	8.8

η	LED
Efficiency	93 lm/W
Direct/Indirect	↓ 100% / ↑ 0%
System Power	14 W
UGR	X=4H, Y=8H
Reflection factors	70/50/20
UGR C0/C180	18.2
UGR C90/C270	18.2
CIE Flux Codes	97 99 100 100 100
Ra/CRI	>80

LTS

Accessories



ZDAR 125.145-205
compensation ring for ceiling cut-outs from 145 to 205 mm