

SCEKLP 33.3030.15

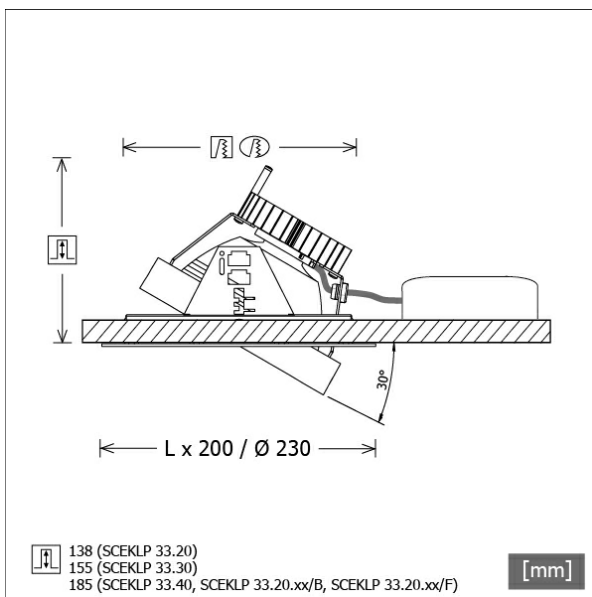

Colours	Article no.	EAN
white	619316	4043544405838
silver	619317	4043544405821
black	619327	4043544405814



Description

- flexible recessed spotlight system consisting of recessed frames, light-heads and ballasts (recessed frames to be ordered separately)
- light-head pivots through 30° on gimbals
- outstanding ease of maintenance
- no UV and thermal emissions
- thermal management with passive cooling (heat sink made from aluminium)
- gimbals made from die-cast zinc
- specular aluminium reflector with precise symmetrical beam characteristic for high luminous efficiency and glare-free lighting
- clear safety glass
- tool-free installation into mounting frame via flexible retaining springs
- connection to ballast via luminaire cable with Mini-Clamp connector
- ballast (LED converter) included (external placement)

Standard options



Special options



Lighting data / Norms

Lamps	LED Spot / CRI 80 / 3000 K
EPREL light sources	851239
Lifetime	L90 B50 50.000 h
	L80 B50 100.000 h
	L80 B20 50.000 h
System power	32.8 W
Luminaire luminous flux	3310 lm
System efficiency	100.91 lm/W
Module efficiency	158.91 lm/W
UGR class	≤19
Beam range	Spot
Beam angle	16°
Supply voltage	220 - 240 V / 50 - 60 Hz
Protection class	III
Type of protection	IP20

Dimensions / Weights

Height	157 mm
Recessed depth	155 mm
Diameter of light head	155 mm
Net weight	1.16 kg
Gross weight	1.25 kg

SCEKLP 33.3030.15

SCEKLP 33.3030.15

Scene 33 System | Light-Head (1xLED 33W 830/3000K 3310lm 15°)

— C0/C180 cd / 1000 lm

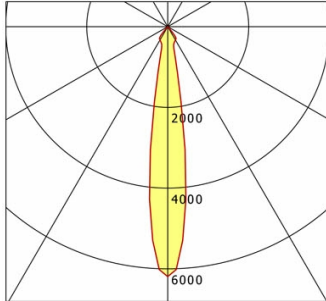

	C0	C90	C180	C270
0°	6190	6190	6190	6190
15°	626	626	626	626
30°	380	380	380	380
45°	26	26	26	26
60°	1	1	1	1
75°	1	1	1	1
90°	0	0	0	0
cd / 1000 lm				

Offset [m] Cone width [m] Illuminance [lx]

Offset [m]	Cone width [m]	Illuminance [lx]
3.0	0.84	2276.7
6.0	1.68	569.2
9.0	2.52	253.0
12.0	3.36	142.3
15.0	4.20	91.1

η	LED
Efficiency	101 lm/W
Direct/Indirect	↓ 100% / ↑ 0%
System Power	33 W
UGR	X=4H, Y=8H
Reflection factors	70/50/20
UGR C0/C180	18.4
UGR C90/C270	18.4
CIE Flux Codes	97 100 100 100 100
Ra/CRI	>80

LTS

Accessories



SCER 33.100
mounting frame 1-lamp



SCER 33.200
mounting frame 2-lamp



SCER 33.300
mounting frame 3-lamp



SCER 33.400
mounting frame 4-lamp