

CSALP 50.3027.50



Description

- recessed spotlight with conical light-head
- suitable for lighting of vertical surfaces
- luminaire rotates through 350° and light-head pivots out through 35°
- outstanding ease of maintenance
- no UV and thermal emissions
- thermal management with passive cooling (heat sink made from aluminium)
- specular aluminium reflector with precise symmetrical beam characteristic for high luminous efficiency and glare-free lighting
- front/recessed ring and light-head made from die-cast zinc
- clear safety glass
- tool-free ceiling mounting via quick-action clamping springs (automatic adjustment of the ceiling thickness)
- luminaire and ballast permanently connected via cable (length: 500 mm), ballast ready for mains connection
- ballast (LED converter) included (external placement)

Standard options



Special options



Colours	Article no.	EAN
black	643543	4043544497499
silver	643544	4043544497505
white	643545	4043544497512

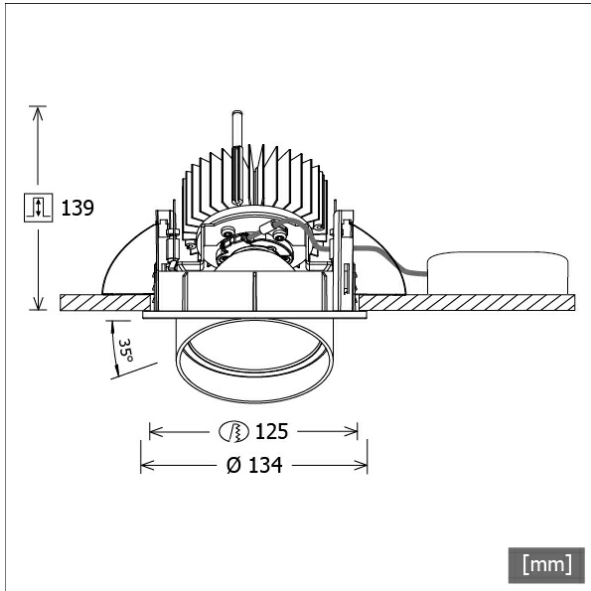

Lighting data / Norms

Lamps	LED Spot / CRI 80 / 2700 K
EPREL light sources	970823
Lifetime	L90 B50 50.000 h L80 B50 100.000 h L80 B20 50.000 h
System power	36.0 W
Luminaire luminous flux	3320 lm
System efficiency	92.22 lm/W
Module efficiency	128.62 lm/W
UGR class	≤22
Beam angle	50°
Supply voltage	220 - 240 V / 50 - 60 Hz
Protection class	II
Type of protection	IP20

Dimensions / Weights

Outer diameter	134 mm
Height	144 mm
Cut-out (Ø)	125 mm
Ceiling thickness	1.0 - 25.0 mm
Recessed depth	139 mm
Net weight	1.27 kg
Gross weight	1.34 kg



CSALP 50.3027.50

CSA 50 (1xLED 36W 827/2700K 3320lm 50 °)

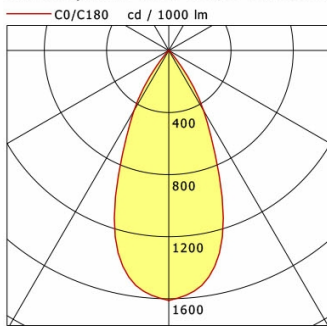

	C0	C90	C180	C270
0°	1611	1611	1611	1611
15°	1300	1300	1300	1300
30°	448	448	448	448
45°	18	18	18	18
60°	5	5	5	5
75°	5	5	5	5
90°	0	0	0	0

cd / 1000 lm

Offset [m]	Cone width [m]	Illuminance [lx]
3.0	2.53	594.4
6.0	5.06	148.6
9.0	7.59	66.0
12.0	10.12	37.1
15.0	12.66	23.8

η	LED
Efficiency	92 lm/W
Direct/Indirect	↓ 100% / ↑ 0%
System Power	36 W
UGR	X=4H, Y=8H
Reflection factors	70/50/20
UGR C0/C180	21.1
UGR C90/C270	21.1
CIE Flux Codes	97 99 100 100 100
Ra/CRI	>80

LTS

Accessories



ZDAR 125.145-205
compensation ring for ceiling cut-outs from 145 to 205 mm