

# SCEKLP 10.3030.25/DALI

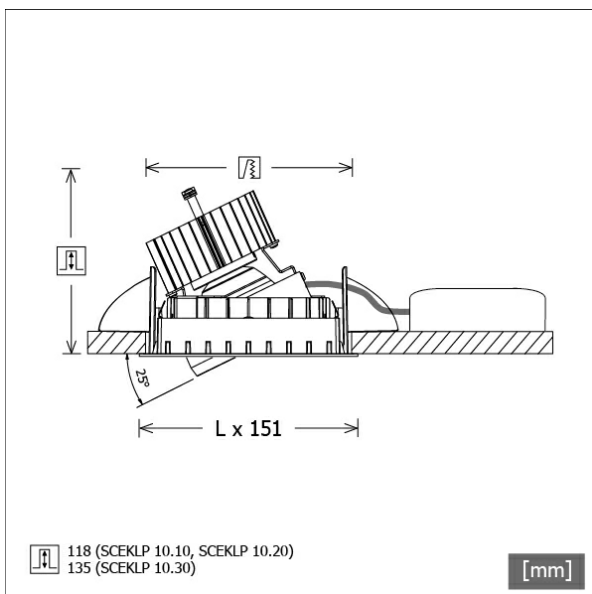

Colours	Article no.	EAN
black	644083	4043544503107
silver	644084	4043544503114
white	644085	4043544503121



## Description

- flexible recessed spotlight system consisting of recessed frames, light-heads and ballasts (recessed frames to be ordered separately)
- adjustable ceiling look: flush with ceiling or recessed by 6 mm
- light-head rotates through 350° and pivots through 25°
- outstanding ease of maintenance
- no UV and thermal emissions
- light-head consisting of front frame (die-cast magnesium) and front ring (die-cast zinc)
- thermal management with passive cooling (heat sink made from aluminium)
- specular aluminium reflector with precise symmetrical beam characteristic for high luminous efficiency and glare-free lighting
- light-head snaps into mounting frame without tools
- connection to ballast via luminaire cable with Mini-Clamp connector
- ballast (LED converter DALI, dimmable) included (external placement)

## Standard options



## Special options

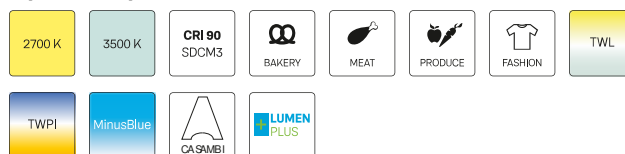

## Lighting data / Norms

Lamps	LED Spot / CRI 80 / 3000 K
EPREL light sources	851239
Lifetime	L90 B50 50.000 h
	L80 B50 100.000 h
	L80 B20 50.000 h
System power	32.8 W
Luminaire luminous flux	3620 lm
System efficiency	110.36 lm/W
Module efficiency	158.91 lm/W
UGR class	≤22
Beam range	Medium Flood
Beam angle	23°
Supply voltage	220 - 240 V / 50 - 60 Hz
Protection class	III
Type of protection	IP20

## Dimensions / Weights

Length	125 mm
Width	125 mm
Height	138 mm
Recessed depth	135 mm
Diameter of light head	100 mm
Net weight	1.04 kg
Gross weight	1.09 kg

# SCEKLP 10.3030.25/DALI

## SCEKLP 10.3030.25/DALI

Scene 1 System | Light-Head (1xLED 33W 830/3000K 3620lm)

C0/C180 cd / 1000 lm

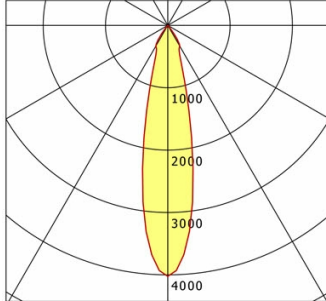

	C0	C90	C180	C270
0°	4024	4024	4024	4024
15°	1215	1215	1215	1215
30°	383	383	383	383
45°	8	8	8	8
60°	3	3	3	3
75°	2	2	2	2
90°	0	0	0	0
cd / 1000 lm				

Offset [m] Cone width [m] Illuminance [lx]

Offset [m]	Cone width [m]	Illuminance [lx]
3.0	1.20	1618.4
6.0	2.40	404.6
9.0	3.60	179.8
12.0	4.80	101.2
15.0	6.01	64.7

<b>η</b>	LED
Efficiency	110 lm/W
Direct/Indirect	↓ 100% / ↑ 0%
System Power	33 W
<b>UGR</b>	X=4H, Y=8H
Reflection factors	70/50/20
UGR C0/C180	20.3
UGR C90/C270	20.3
CIE Flux Codes	99 99 100 100 100
Ra/CRI	>80

LTS

## Accessories



**SCER 1.100**  
mounting frame 1-lamp



**SCER 1.200**  
mounting frame 2-lamp



**SCER 1.300**  
mounting frame 3-lamp



**ZB-OR DONGLE**  
Organic Response IR dongle kit



**ZB-OR GATEWAY**  
Organic Response IoT Gateway Cascade Series



**ZB-OR-R SENSOR**  
Organic Response sensor for recessed mounting