

# CSALP 50.2030.25



## Description

- recessed spotlight with conical light-head
- suitable for lighting of vertical surfaces
- luminaire rotates through 350° and light-head pivots out through 35°
- outstanding ease of maintenance
- no UV and thermal emissions
- thermal management with passive cooling (heat sink made from aluminium)
- specular aluminium reflector with precise symmetrical beam characteristic for high luminous efficiency and glare-free lighting
- front/recessed ring and light-head made from die-cast zinc
- clear safety glass
- tool-free ceiling mounting via quick-action clamping springs (automatic adjustment of the ceiling thickness)
- luminaire and ballast permanently connected via cable (length: 500 mm), ballast ready for mains connection
- ballast (LED converter) included (external placement)

## Standard options



## Special options



Colours	Article no.	EAN
black	643483	4043544496898
silver	643484	4043544496904
white	643485	4043544496911

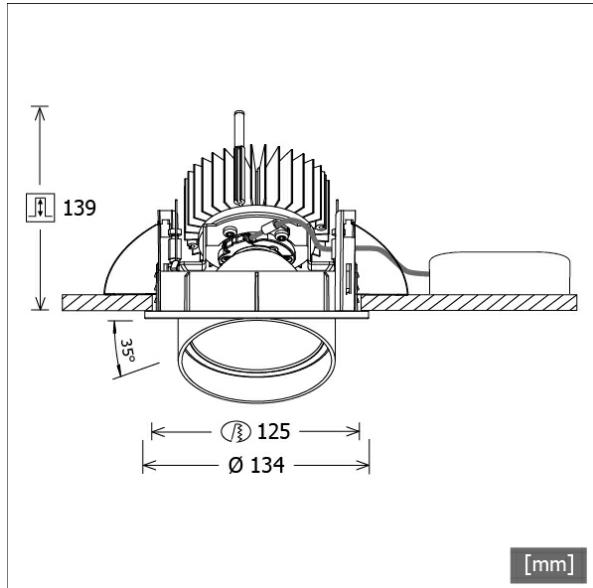

## Lighting data / Norms

<b>Lamps</b>	LED Spot / CRI 80 / 3000 K
<b>EPREL light sources</b>	848117
	L90 B50 50.000 h
	L80 B50 100.000 h
	L80 B20 50.000 h
<b>Lifetime</b>	
<b>System power</b>	27.0 W
<b>Luminaire luminous flux</b>	2700 lm
<b>System efficiency</b>	100.00 lm/W
<b>Module efficiency</b>	156.64 lm/W
<b>UGR class</b>	≤19
<b>Beam angle</b>	25°
<b>Supply voltage</b>	220 - 240 V / 50 - 60 Hz
<b>Protection class</b>	II
<b>Type of protection</b>	IP20

## Dimensions / Weights

<b>Outer diameter</b>	134 mm
<b>Height</b>	144 mm
<b>Cut-out (Ø)</b>	125 mm
<b>Ceiling thickness</b>	1.0 - 25.0 mm
<b>Recessed depth</b>	139 mm
<b>Net weight</b>	1.24 kg
<b>Gross weight</b>	1.32 kg

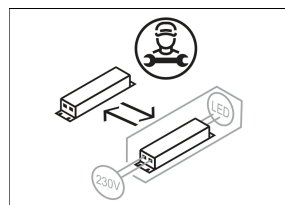

# CSALP 50.2030.25

CSA 50 (1xLED 27W 830/3000K 2700lm 25 °)

C0/C180 cd / 1000 lm

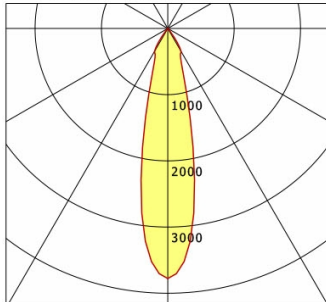

	C0	C90	C180	C270
0°	3777	3777	3777	3777
15°	1204	1204	1204	1204
30°	398	398	398	398
45°	10	10	10	10
60°	5	5	5	5
75°	3	3	3	3
90°	0	0	0	0
cd / 1000 lm				

Offset [m] Cone width [m] Illuminance [lx]

Offset [m]	Cone width [m]	Illuminance [lx]
3.0	1.25	1133.2
6.0	2.50	283.3
9.0	3.76	125.9
12.0	5.01	70.8
15.0	6.26	45.3

<b>η</b>	LED
Efficiency	100 lm/W
Direct/Indirect	↓ 100% / ↑ 0%
System Power	27 W
<b>UGR</b>	X=4H, Y=8H
Reflection factors	70/50/20
UGR C0/C180	19.2
UGR C90/C270	19.2
CIE Flux Codes	98 99 100 100 100
Ra/CRI	>80

LTS

## Accessories



**ZDAR 125.145-205**  
compensation ring for ceiling cut-outs from 145 to 205 mm