

SCEKLP 20.2030.15/DALI

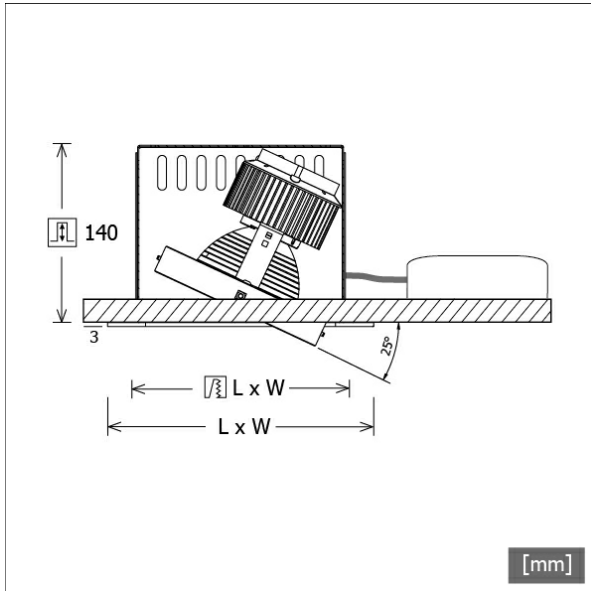

Colours	Article no.	EAN
black	643960	4043544501875
silver	643961	4043544501882
white	643962	4043544501899



Description

- flexible recessed spotlight system consisting of recessed housings, light-heads and ballasts (recessed housings to be ordered separately)
- light-head pivots through 25° with gimbals
- outstanding ease of maintenance
- no UV and thermal emissions
- light-head gimbals made from die-cast zinc
- thermal management with passive cooling (heat sink made from aluminium)
- specular aluminium reflector with precise symmetrical beam characteristic for high luminous efficiency and glare-free lighting
- clear safety glass
- assembly into the recessed housing takes place in the factory
- connection to ballast via luminaire cable with Mini-Clamp connector
- ballast (LED converter DALI, dimmable) included (external placement)

Standard options



Special options

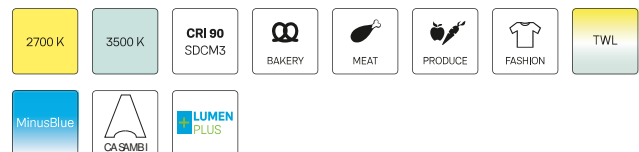

Lighting data / Norms

Lamps	LED Spot / CRI 80 / 3000 K
EPREL light sources	848117
Lifetime	L90 B50 50.000 h
	L80 B50 100.000 h
	L80 B20 50.000 h
System power	25.8 W
Luminaire luminous flux	2710 lm
System efficiency	105.03 lm/W
Module efficiency	156.64 lm/W
UGR class	≤19
Beam range	Spot
Beam angle	14°
Supply voltage	220 - 240 V / 50 - 60 Hz
Protection class	III
Type of protection	IP20

Dimensions / Weights

Height	143 mm
Recessed depth	105 mm
Diameter of light head	140 mm
Net weight	0.97 kg
Gross weight	1.03 kg

SCEKLP 20.2030.15/DALI

SCEKLP 20.2030.15/DALI

Scene 2 System | Light-Head (1xLED 26W 830/3000K 2710lm)

C0/C180 cd / 1000 lm

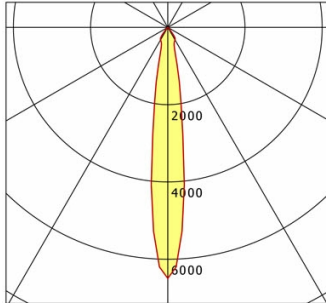

	C0	C90	C180	C270
0°	6495	6495	6495	6495
15°	830	830	830	830
30°	374	374	374	374
45°	20	20	20	20
60°	2	2	2	2
75°	0	0	0	0
90°	0	0	0	0
cd / 1000 lm				

Offset [m] Cone width [m] Illuminance [lx]

Offset [m]	Cone width [m]	Illuminance [lx]
3.0	0.76	1955.6
6.0	1.52	488.9
9.0	2.28	217.3
12.0	3.04	122.2
15.0	3.80	78.2

η	LED
Efficiency	105 lm/W
Direct/Indirect	↓ 100% / ↑ 0%
System Power	26 W
UGR	X=4H, Y=8H
Reflection factors	70/50/20
UGR C0/C180	19.1
UGR C90/C270	19.1
CIE Flux Codes	98 100 100 100 100
Ra/CRI	>80

LTS

Accessories



SCER 2.1140
recessed housing 1-lamp



SCER 2.2140
recessed housing 2-lamp



SCER 2.3140
recessed housing 3-lamp



SCER 2.4140
recessed housing 4-lamp



ZB-OR DONGLE
Organic Response IR dongle kit



ZB-OR GATEWAY
Organic Response IoT Gateway Cascade Series



ZB-OR-R SENSOR
Organic Response sensor for recessed mounting