

Gültig für Betoneinbaugehäuse / valid for concrete recessed housings		
Lichtkanal 045	Lichtkanal 070	Lichtkanal 110
LK-Z 045.005.1 BT/...	LK-Z 070.005.1 BT/...	LK-Z 110.005.1 BT/...
LK-Z 045.005.2 BT/...	LK-Z 070.005.2 BT/...	LK-Z 110.005.2 BT/...

Zentrierdeckel gemäß Abbildung ❶ auf Schalung ausrichten und befestigen. **Auf richtige Lage von Ober- und Unterseite von Zentrierdeckel achten.**

Align centering cover on boarding and fix it according to figure ❶. Pay attention to correct situation of upper and lower surface of the centering cover.

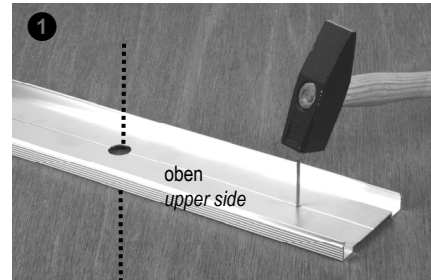

Betoneinbauprofil auf Zentrierdeckel gemäß Abbildung ❷ auf-schnappen.

Snap concrete casting profile on covering plate according to figure ❷.

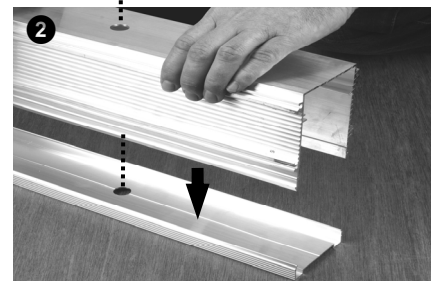

Betoneinbauprofil mit Spax und Kunststoff-Unterlegscheiben gemäß Abbildung ❸ auf Schalung fixieren. **Beim Eindrehen der Spax Unterlegscheiben nicht deformieren, Drehmoment beachten.**

Fix concrete casting profile on the boarding with drywall screws and plastic washers according to figure ❸. When screwing in drywall screws don't damage the washers. Pay attention to the torque.



Betoneinbauprofile gemäß Abbildung ❹ mit Längsverbindern zusammenmontieren.

Assemble according to figure ❹ the concrete casting profiles with the aid of the longitudinal connectors.



Enddeckel gemäß Abbildung ❺ montieren. Installationsschläuche durch Kabeltüllen einführen bzw. durchschleifen. **Vor dem Einziehen der Kabel überstehende Installationsschläuche und Kabeltüllen gemäß Abbildung ❻ und ❼ abschneiden.**

Mount end covers according to figure ❺. Pushing-in or through-wiring of the flexible installation tubes through cable support sleeves.

Cut off protruding installation hoses and cable support sleeves in accordance with figures ❻ and ❼, before drawing in the cables.

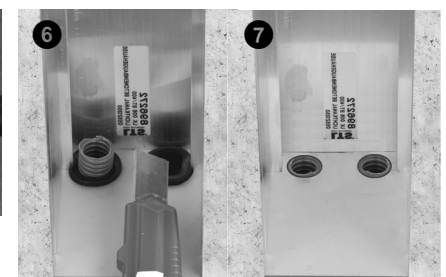
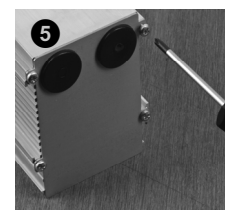

D

- **Beachten Sie folgende Hinweisblätter:**
818278 Allgemeines Hinweisblatt für Leuchten
- **IP40 gilt nur in Verbindung mit montiertem Acrylglasprofil.**
Die thermische Längenausdehnung des Aluminiumprofils beträgt bei $dT = 10$ Kelvin 0.3 mm pro Meter.
- Beachten sie die angegebenen Montageanweisungen in der Tabelle.

GB

- Consider the following installation instructions and notes:**
818278 general notes for luminaires
- IP40 only applies in with mounted acrylic glass profile.**
The linear thermal expansion of the aluminium profile is about 0.3 mm per meter at $dT = 10$ Kelvin.
Consider the given installation instructions in the table.

Trimless Gipskartonmontage <i>trimless plaster board mounting</i>		Trimless Sichtbetonmontage <i>trimless fairfaced concrete mounting</i>		Beton-Putzdecken-Montage <i>plaster concrete mounting</i>	
Einbaurahmen + Einbauprofil <i>mounting frame + profile</i>	Montageanweisungen <i>installation instructions</i>	Einbaurahmen + Einbauprofil <i>mounting frame + profile</i>	Montageanweisungen <i>installation instructions</i>	Einbaurahmen + Einbauprofil <i>mounting frame + profile</i>	Montageanweisungen <i>installation instructions</i>
LK-Z 045.003...+ LK-P 045.003...	970571 + 826782	LK-Z 045.005.1 BT...+ LK-P 045.005.1...	825038+ 826782	LK-Z 045.005.2 BT...+ LK-P 045.005.2...	825038+ 826783
LK-Z 070.003...+ LK-P 070.003...	970571 + 841109	LK-Z 070.005.1 BT...+ LK-P 070.005.1...	825038 + 841109	LK-Z 070.005.2 BT...+ LK-P 070.005.2...	825038 + 841110

Trimless Gipskartonmontage / *trimless plaster board mounting*

LK-Z + LK-P 045.003... / LK-Z + LK-P 070.003...

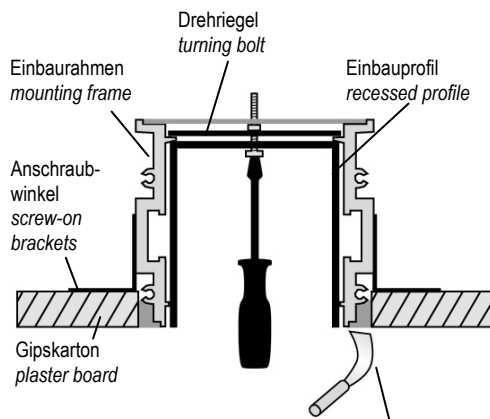

UV- und hitzebeständige Spachtelmasse verwenden!
Use UV and heat resistant filler.

Trimless Sichtbetonmontage / *trimless fairfaced concrete mounting*

LK-Z + LK-P 045.005.1... / LK-Z + LK-P 070.005.1...

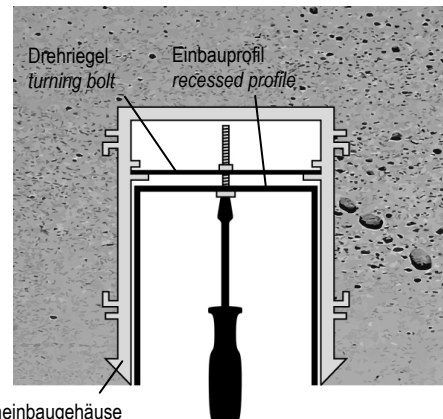

Betoneinbaugehäuse
concrete recessed housing

Beton-Putzdecken-Montage / *plaster concrete mounting*

LK-Z + LK-P 045.005.2... / LK-Z + LK-P 070.005.2...

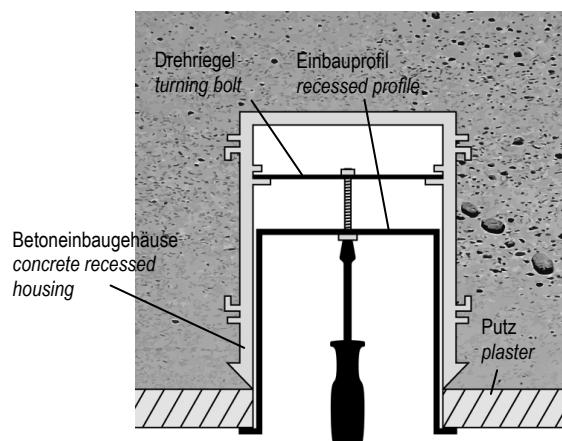

D

- **Beachten Sie folgende Montageanweisungen und Hinweise:**
818278 Allgemeines Hinweisblatt für LED-Leuchten
827473 Montageanweisung für AOV Abschirmfolie ⑧
Beigelegte Montageanweisungen für Verbinder, Beton- und Trimless-Einbau beachten. Einbaumontage siehe Detail ① (Rückseite).
- **IP40 gilt nur in Verbindung mit montiertem Acrylglasprofil.** Die thermische Längenausdehnung des Aluminiumprofils beträgt bei $dT = 10$ Kelvin 0.3 mm pro Meter.
- **Einbaulänge:** Profillänge + 2×3 mm (Enddeckelstärke)
Ausschnitt: (Einbaulänge + 2 mm) x 74 mm
Einbautiefe: 100 mm
Deckenstärke: $6 - 25$ mm
Spannbügelweite: max. 220 mm

GB

- Consider the following installation instructions and notes:**
818278 general notes for LED luminaires
827473 installation instruction for AOV shielding foil ⑧
Consider the enclosed installation instructions for connectors, concrete and trimless mounting. Recessed mounting see detail ① (on the back).
- IP40 only applies in with mounted acrylic glass profile.** The linear thermal expansion of the aluminium profile is about 0.3 mm per meter at $dT = 10$ Kelvin.
- Recessed length:** profile length + 2×3 mm (thickness of end covers)
Cut-out: (recessed length + 2 mm) x 74 mm
Installation depth: 100 mm
Ceiling thickness: $6 - 25$ mm
Required clamps space: max. 220 mm

