

CSALP 50.3027.25



Description

- recessed spotlight with conical light-head
- suitable for lighting of vertical surfaces
- luminaire rotates through 350° and light-head pivots out through 35°
- outstanding ease of maintenance
- no UV and thermal emissions
- thermal management with passive cooling (heat sink made from aluminium)
- specular aluminium reflector with precise symmetrical beam characteristic for high luminous efficiency and glare-free lighting
- front/recessed ring and light-head made from die-cast zinc
- clear safety glass
- tool-free ceiling mounting via quick-action clamping springs (automatic adjustment of the ceiling thickness)
- luminaire and ballast permanently connected via cable (length: 500 mm), ballast ready for mains connection
- ballast (LED converter) included (external placement)

Standard options



Special options



Colours	Article no.	EAN
black	643531	4043544497376
silver	643532	4043544497383
white	643533	4043544497390

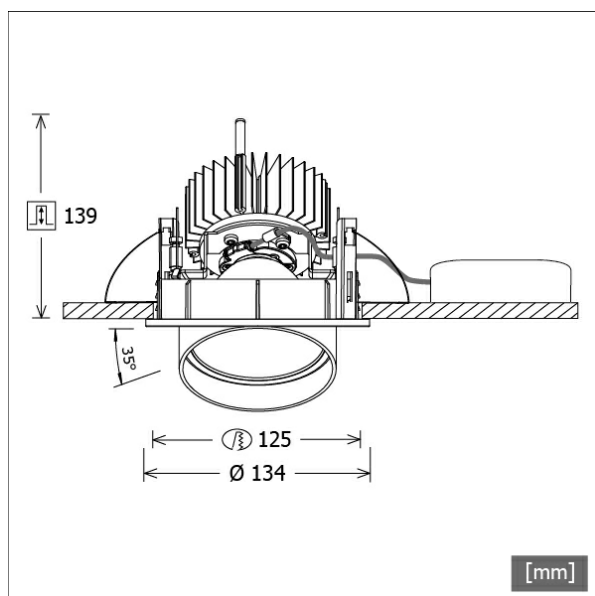

Lighting data / Norms

Lamps	LED Spot / CRI 80 / 2700 K
EPREL light sources	970823
	L90 B50 50.000 h
	L80 B50 100.000 h
	L80 B20 50.000 h
Lifetime	
System power	36.0 W
Luminaire luminous flux	3410 lm
System efficiency	94.72 lm/W
Module efficiency	128.62 lm/W
UGR class	≤22
Beam angle	25°
Supply voltage	220 - 240 V / 50 - 60 Hz
Protection class	II
Type of protection	IP20

Dimensions / Weights

Outer diameter	134 mm
Height	144 mm
Cut-out (Ø)	125 mm
Ceiling thickness	1.0 - 25.0 mm
Recessed depth	139 mm
Net weight	1.27 kg
Gross weight	1.34 kg



CSALP 50.3027.25

CSA 50 (1xLED 36W 827/2700K 3410lm 25 °)

C0/C180 cd / 1000 lm

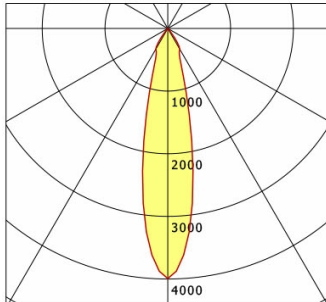

	C0	C90	C180	C270
0°	3992	3992	3992	3992
15°	1223	1223	1223	1223
30°	381	381	381	381
45°	8	8	8	8
60°	3	3	3	3
75°	2	2	2	2
90°	0	0	0	0
cd / 1000 lm				

Offset [m] Cone width [m] Illuminance [lx]

Offset [m]	Cone width [m]	Illuminance [lx]
3.0	1.20	1512.5
6.0	2.41	378.1
9.0	3.61	168.1
12.0	4.82	94.5
15.0	6.02	60.5

η	LED
Efficiency	95 lm/W
Direct/Indirect	↓ 100% / ↑ 0%
System Power	36 W
UGR	X=4H, Y=8H
Reflection factors	70/50/20
UGR C0/C180	20.1
UGR C90/C270	20.1
CIE Flux Codes	99 99 100 100 100
Ra/CRI	>80

LTS

Accessories



ZDAR 125.145-205
compensation ring for ceiling cut-outs from 145 to 205 mm