

SCEKLP 20.3030.25

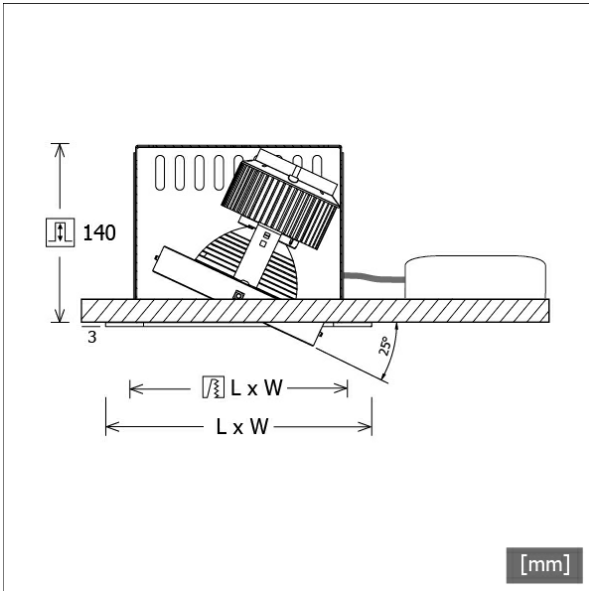

Colours	Article no.	EAN
black	638370	4043544420619
silver	638371	4043544420626
white	638372	4043544420633



Description

- flexible recessed spotlight system consisting of recessed housings, light-heads and ballasts (recessed housings to be ordered separately)
- light-head pivots through 25° with gimbals
- outstanding ease of maintenance
- no UV and thermal emissions
- light-head gimbals made from die-cast zinc
- thermal management with passive cooling (heat sink made from aluminium)
- specular aluminium reflector with precise symmetrical beam characteristic for high luminous efficiency and glare-free lighting
- clear safety glass
- assembly into the recessed housing takes place in the factory
- connection to ballast via luminaire cable with Mini-Clamp connector
- ballast (LED converter) included (external placement)

Standard options



Special options



Lighting data / Norms

Lamps	LED Spot / CRI 80 / 3000 K
EPREL light sources	851239
Lifetime	L90 B50 50.000 h
	L80 B50 100.000 h
	L80 B20 50.000 h
System power	32.8 W
Luminaire luminous flux	3580 lm
System efficiency	109.14 lm/W
Module efficiency	158.91 lm/W
UGR class	≤22
Beam range	Medium Flood
Beam angle	27°
Supply voltage	220 - 240 V / 50 - 60 Hz
Protection class	III
Type of protection	IP20

Dimensions / Weights

Height	143 mm
Recessed depth	122 mm
Diameter of light head	140 mm
Net weight	0.96 kg
Gross weight	1.02 kg

SCEKLP 20.3030.25

SCEKLP 20.3030.25

Scene 2 System | Light-Head (1xLED 33W 830/3000K 3580lm)

C0/C180 cd / 1000 lm

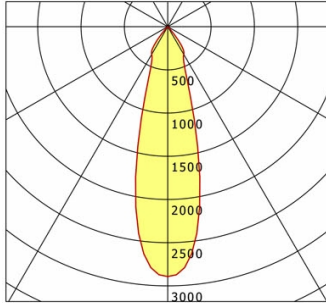

	C0	C90	C180	C270
0°	2892	2892	2892	2892
15°	1259	1259	1259	1259
30°	370	370	370	370
45°	22	22	22	22
60°	3	3	3	3
75°	0	0	0	0
90°	0	0	0	0
cd / 1000 lm				

Offset [m] Cone width [m] Illuminance [lx]

Offset [m]	Cone width [m]	Illuminance [lx]
3.0	1.49	1150.4
6.0	2.98	287.6
9.0	4.47	127.8
12.0	5.95	71.9
15.0	7.44	46.0

η	LED
Efficiency	109 lm/W
Direct/Indirect	↓ 100% / ↑ 0%
System Power	33 W
UGR	X=4H, Y=8H
Reflection factors	70/50/20
UGR C0/C180	20.1
UGR C90/C270	20.1
CIE Flux Codes	98 100 100 100 100
Ra/CRI	>80

LTS

Accessories



SCER 2.1140
recessed housing 1-lamp



SCER 2.2140
recessed housing 2-lamp



SCER 2.3140
recessed housing 3-lamp



SCER 2.4140
recessed housing 4-lamp