

CSALP 50.1027.35/DALI



Description

- recessed spotlight with conical light-head
- suitable for lighting of vertical surfaces
- luminaire rotates through 350° and light-head pivots out through 35°
- outstanding ease of maintenance
- no UV and thermal emissions
- thermal management with passive cooling (heat sink made from aluminium)
- specular aluminium reflector with precise symmetrical beam characteristic for high luminous efficiency and glare-free lighting
- front/recessed ring and light-head made from die-cast zinc
- clear safety glass
- tool-free ceiling mounting via quick-action clamping springs (automatic adjustment of the ceiling thickness)
- luminaire and ballast permanently connected via cable (length: 500 mm), ballast ready for mains connection
- ballast (LED converter DALI, dimmable) included (external placement)

Standard options



Special options



Colours	Article no.	EAN
black	643396	4043544496027
silver	643397	4043544496034
white	643398	4043544496041

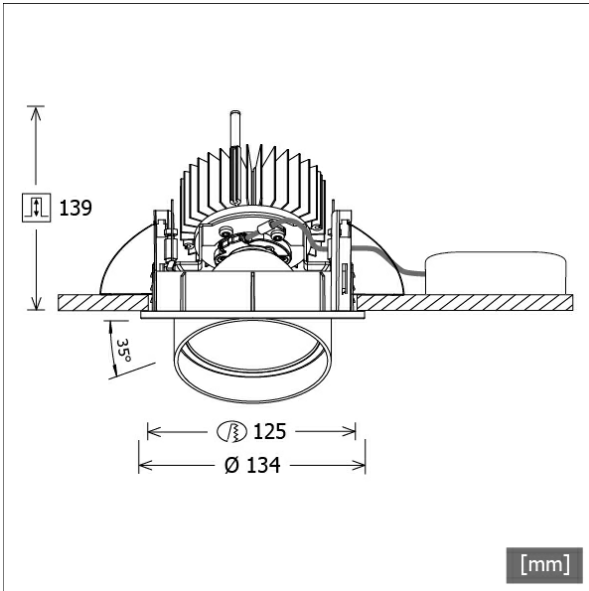

Lighting data / Norms

Lamps	LED Spot / CRI 80 / 2700 K
EPREL light sources	848120
Lifetime	L90 B50 50.000 h L80 B50 100.000 h L80 B20 50.000 h
System power	14.0 W
Luminaire luminous flux	1320 lm
System efficiency	94.28 lm/W
Module efficiency	127.18 lm/W
UGR class	≤19
Beam angle	35°
Supply voltage	220 - 240 V / 50 - 60 Hz
Protection class	II
Type of protection	IP20

Dimensions / Weights

Outer diameter	134 mm
Height	144 mm
Cut-out (Ø)	125 mm
Ceiling thickness	1.0 - 25.0 mm
Recessed depth	139 mm
Net weight	1.21 kg
Gross weight	1.30 kg



CSALP 50.1027.35/DALI

CSA 50 (1xLED 14W 827/2700K 1320lm 35 °)

C0/C180 cd / 1000 lm

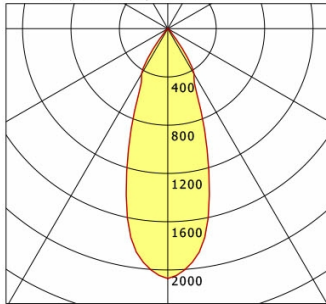

	C0	C90	C180	C270
0°	2071	2071	2071	2071
15°	1326	1326	1326	1326
30°	435	435	435	435
45°	19	19	19	19
60°	7	7	7	7
75°	4	4	4	4
90°	0	0	0	0
cd / 1000 lm				

Offset [m] Cone width [m] Illuminance [lx]

Offset [m]	Cone width [m]	Illuminance [lx]
3.0	1.97	303.7
6.0	3.95	75.9
9.0	5.92	33.7
12.0	7.89	19.0
15.0	9.87	12.1

η	LED
Efficiency	94 lm/W
Direct/Indirect	↓ 100% / ↑ 0%
System Power	14 W
UGR	X=4H, Y=8H
Reflection factors	70/50/20
UGR C0/C180	18.2
UGR C90/C270	18.2
CIE Flux Codes	97 99 100 100 100
Ra/CRI	>80

LTS

Accessories



ZB-OR DONGLE
Organic Response IR dongle kit



ZB-OR GATEWAY
Organic Response IoT Gateway Cascade Series



ZB-OR-R SENSOR
Organic Response sensor for recessed mounting



ZDAR 125.145-205
compensation ring for ceiling cut-outs from 145 to 205 mm