

SCEKLP 33.2040.25/DALI

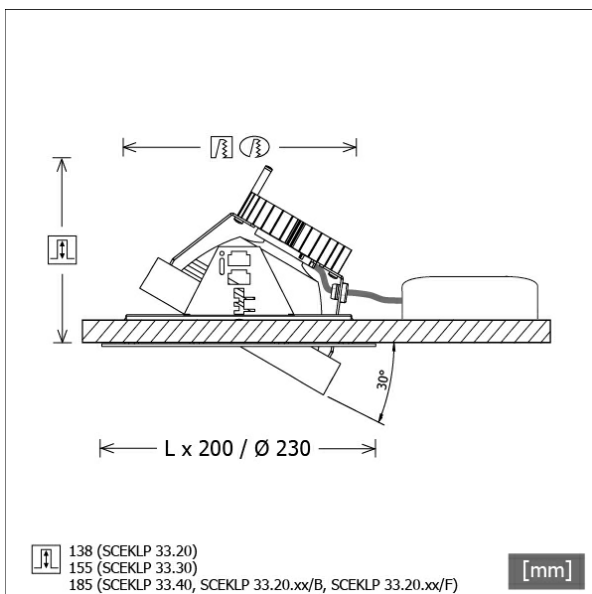

Colours	Article no.	EAN
black	643759	4043544499653
silver	643760	4043544499660
white	643761	4043544499677



Description

- flexible recessed spotlight system consisting of recessed frames, light-heads and ballasts (recessed frames to be ordered separately)
- light-head pivots through 30° on gimbals
- outstanding ease of maintenance
- no UV and thermal emissions
- thermal management with passive cooling (heat sink made from aluminium)
- gimbals made from die-cast zinc
- specular aluminium reflector with precise symmetrical beam characteristic for high luminous efficiency and glare-free lighting
- clear safety glass
- tool-free installation into mounting frame via flexible retaining springs
- connection to ballast via luminaire cable with Mini-Clamp connector
- ballast (LED converter DALI, dimmable) included (external placement)

Standard options



Special options



Lighting data / Norms

Lamps	LED Spot / CRI 80 / 4000 K
EPREL light sources	848119
Lifetime	L90 B50 50.000 h
	L80 B50 100.000 h
	L80 B20 50.000 h
System power	25.8 W
Luminaire luminous flux	2890 lm
System efficiency	112.01 lm/W
Module efficiency	160.37 lm/W
UGR class	≤19
Beam range	Medium Flood
Beam angle	23°
Supply voltage	220 - 240 V / 50 - 60 Hz
Protection class	III
Type of protection	IP20

Dimensions / Weights

Height	140 mm
Recessed depth	138 mm
Diameter of light head	155 mm
Net weight	1.16 kg
Gross weight	1.29 kg

SCEKLP 33.2040.25/DALI

SCEKLP 33.2040.25/DALI

Scene 33 System | Light-Head (1xLED 26W 840/4000K 2890lm 25°)

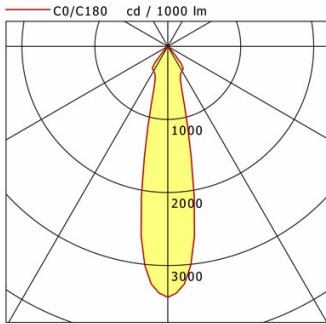

	C0	C90	C180	C270
0°	3436	3436	3436	3436
15°	954	954	954	954
30°	388	388	388	388
45°	28	28	28	28
60°	6	6	6	6
75°	2	2	2	2
90°	0	0	0	0
cd / 1000 lm				

Offset [m]	Cone width [m]	Illuminance [lx]
3.0	1.21	1103.2
6.0	2.42	275.8
9.0	3.62	122.6
12.0	4.83	69.0
15.0	6.04	44.1

η	LED
Efficiency	111 lm/W
Direct/Indirect	↓ 100% / ↑ 0%
System Power	26 W
UGR	X=4H, Y=8H
Reflection factors	70/50/20
UGR C0/C180	18.4
UGR C90/C270	18.4
CIE Flux Codes	96 99 100 100 100
Ra/CRI	>80

LTS

Accessories



SCER 33.100
mounting frame 1-lamp



SCER 33.200
mounting frame 2-lamp



SCER 33.300
mounting frame 3-lamp

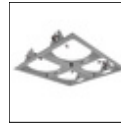

SCER 33.400
mounting frame 4-lamp



ZB-OR DONGLE
Organic Response IR dongle kit



ZB-OR GATEWAY
Organic Response IoT Gateway Cascade Series



ZB-OR-R SENSOR
Organic Response sensor for recessed mounting