

Mounted 48 V

NEO-A 30/9500-3/ST6-E



Description

- 48 V surface-mounted track with data bus (length: 3000 mm)
- realisation of lighting tasks with DALI technology
- 4-conductor track for two separate supplies or one circuit for the supply and one for the data bus
- extruded aluminium profile
- length can be adjusted on site by easily shortening the track (cutting tool ST-ZCUT/S-9000/T-N required for shortening the copper conductors)
- can be used for ceiling or pendant mounting with suitable fixing accessories (mechanical load diagramm see data sheet)
- rated current and voltage: 15 A / 60 V DC
- 2 circuits: 2x (+/- 15 A / 0 - 60 V)
- 1 circuit and data bus: +/- 15 A / 0 - 60 V and D+/D-
- system components to be ordered separately

Standard options



Dimensions / Weights

Length	3000 mm
Width	26 mm
Height	29 mm
Net weight	2.88 kg
Gross weight	3.03 kg

Colours	Article no.	EAN
black	664244	4043544733795
white	664245	4043544733801

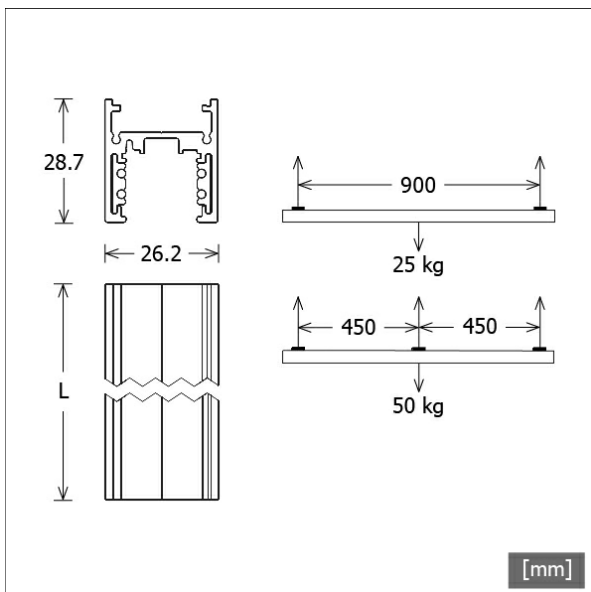

Mounted 48 V

NEO-A 30/9500-3/ST6-E

Accessories



NEO-A CAP ESP/9504/ST6-F
end cover for 48 V surface-mounted track with feed-in opening



NEO-A CAP/9504/ST6
end cover for 48 V surface-mounted track



NEO-A L/IN/9511-KI-E
L-connector with polarity inside



NEO-A L/OUT/9511-KE-E
L-connector with polarity outside



NEO-A L/S/S-9511/ST6
L-connector mechanical

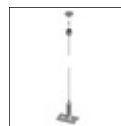

NEO-A S/9500-KIT1-3/3000
wire-rope suspension (length: 3000 mm) + fixing clamp



NEO-A S/S-9500-114
ceiling bracket



NEO-A S/S-9500/323-LA
mechanical coupler (outside)

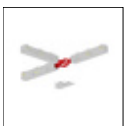

NEO-A T/PE-IN-L/9515-K-E
T-connector with polarity inside left

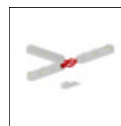

NEO-A T/PE-IN-R/9516-K-E
T-connector with polarity inside right

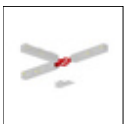

NEO-A T/PE-OUT-L/9513-K-E
T-connector with polarity outside left

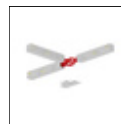

NEO-A T/PE-OUT-R/9514-K-E
T-connector with polarity outside right

Mounted 48 V

NEO-A 30/9500-3/ST6-E

Accessories



NEO-A T/S/S-9513/P-ST6
T-connector mechanical

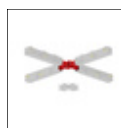

NEO-A X/9517-K-E
X-connector with polarity



NEO-A X/S/S-9517/P-ST6
X-connector mechanical



NEO-F/L/9501-S-KL-E
end feed-in with polarity left



NEO-F/R/9501-S-KR-E
end feed-in with polarity rechts



NEO-IE/9503-S-K-E
electric linear connector



NEO-ZLA/9519-166-M-K-E
adapter housing for single spotlight



NEO-ZOPC/S-RP-24-48V
optocoupler



NEO-ZPSA/9500/P-1000E-C1-N
power supply for 48 V track



NEO-ZPSP/9500/P-1000E-SP-N
power supply for suspended 48 V track



ST-ZCUT/S-9000/T-N
cutting tool