

Gültig für Betoneinbaugehäuse / valid for concrete recessed housings		
Lichtkanal 045	Lichtkanal 070	Lichtkanal 110
LK-Z 045.005.1 BT/...	LK-Z 070.005.1 BT/...	LK-Z 110.005.1 BT/...
LK-Z 045.005.2 BT/...	LK-Z 070.005.2 BT/...	LK-Z 110.005.2 BT/...

Zentrierdeckel gemäß Abbildung ❶ auf Schalung ausrichten und befestigen. **Auf richtige Lage von Ober- und Unterseite von Zentrierdeckel achten.**

*Align centering cover on boarding and fix it according to figure ❶. Pay attention to correct situation of upper and lower surface of the centering cover.*

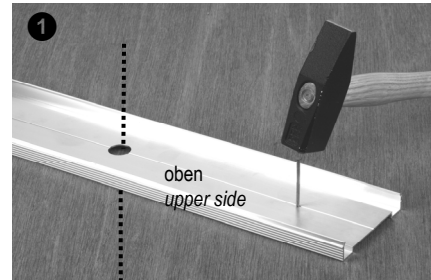

Betoneinbauprofil auf Zentrierdeckel gemäß Abbildung ❷ auf-schnappen.

*Snap concrete casting profile on covering plate according to figure ❷.*

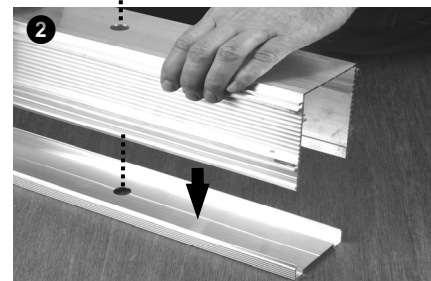

Betoneinbauprofil mit Spax und Kunststoff-Unterlegscheiben gemäß Abbildung ❸ auf Schalung fixieren. **Beim Eindrehen der Spax Unterlegscheiben nicht deformieren, Drehmoment beachten.**

*Fix concrete casting profile on the boarding with drywall screws and plastic washers according to figure ❸. When screwing in drywall screws don't damage the washers. Pay attention to the torque.*



Betoneinbauprofile gemäß Abbildung ❹ mit Längsverbindern zusammenmontieren.

*Assemble according to figure ❹ the concrete casting profiles with the aid of the longitudinal connectors.*



Enddeckel gemäß Abbildung ❺ montieren. Installationsschläuche durch Kabeltüllen einführen bzw. durchschleifen. **Vor dem Einziehen der Kabel überstehende Installationsschläuche und Kabeltüllen gemäß Abbildung ❻ und ❼ abschneiden.**

*Mount end covers according to figure ❺. Pushing-in or through-wiring of the flexible installation tubes through cable support sleeves.*

**Cut off protruding installation hoses and cable support sleeves in accordance with figures ❻ and ❼, before drawing in the cables.**

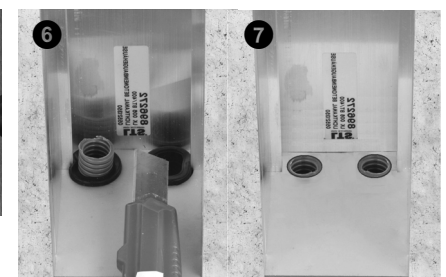
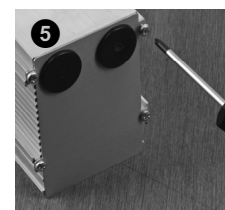

**D**

- **Beachten Sie folgende Hinweisblätter:**  
818278 Allgemeines Hinweisblatt für Leuchten
- **IP40 gilt nur in Verbindung mit montiertem Acrylglasprofil.**  
Die thermische Längenausdehnung des Aluminiumprofils beträgt bei  $dT = 10$  Kelvin 0.3 mm pro Meter.
- Beachten sie die angegebenen Montageanweisungen in der Tabelle.

**GB**

- Consider the following installation instructions and notes:**  
818278 general notes for luminaires
- IP40 only applies in with mounted acrylic glass profile.**  
The linear thermal expansion of the aluminium profile is about 0.3 mm per meter at  $dT = 10$  Kelvin.
- Consider the given installation instructions in the table.

Trimless Gipskartonmontage <i>trimless plaster board mounting</i>		Trimless Sichtbetonmontage <i>trimless fairfaced concrete mounting</i>		Beton-Putzdecken-Montage <i>plaster concrete mounting</i>	
Einbaurahmen + Einbauprofil <i>mounting frame + profile</i>	Montageanweisungen <i>installation instructions</i>	Einbaurahmen + Einbauprofil <i>mounting frame + profile</i>	Montageanweisungen <i>installation instructions</i>	Einbaurahmen + Einbauprofil <i>mounting frame + profile</i>	Montageanweisungen <i>installation instructions</i>
LK-Z 045.003...+ LK-P 045.003...	970571 + 826782	LK-Z 045.005.1 BT...+ LK-P 045.005.1...	825038+ 826782	LK-Z 045.005.2 BT...+ LK-P 045.005.2...	825038+ 826783
LK-Z 070.003...+ LK-P 070.003...	970571 + 841109	LK-Z 070.005.1 BT...+ LK-P 070.005.1...	825038 + 841109	LK-Z 070.005.2 BT...+ LK-P 070.005.2...	825038 + 841110

### Trimless Gipskartonmontage / *trimless plaster board mounting* LK-Z + LK-P 045.003... / LK-Z + LK-P 070.003...

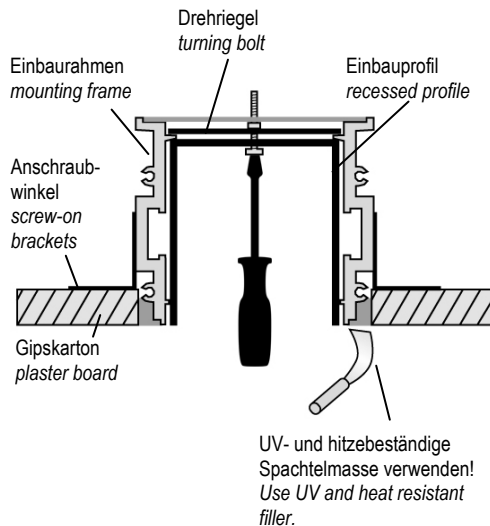

### Trimless Sichtbetonmontage / *trimless fairfaced concrete mounting* LK-Z + LK-P 045.005.1... / LK-Z + LK-P 070.005.1...

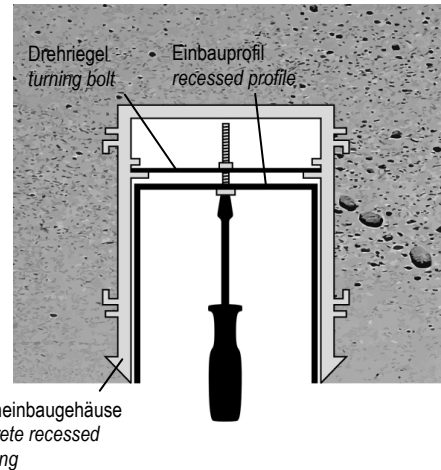

### Beton-Putzdecken-Montage / *plaster concrete mounting* LK-Z + LK-P 045.005.2... / LK-Z + LK-P 070.005.2...

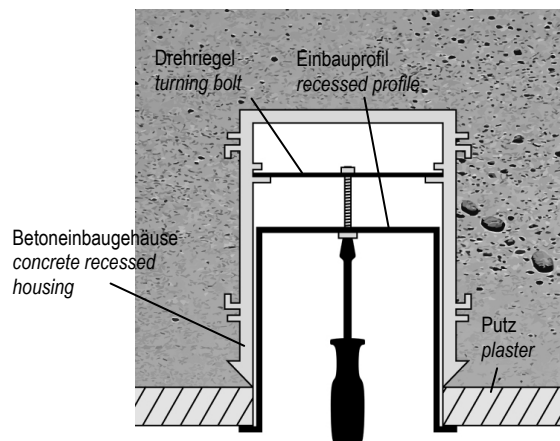

**D**

- **Beachten Sie folgende Montageanweisungen und Hinweise:**  
818278 Allgemeines Hinweisblatt für LED-Leuchten  
827473 Montageanweisung für AOV Abschirmfolie ⑧  
Beigelegte Montageanweisungen für Verbinder, Beton- und Trimless-Einbau beachten. Einbaumontage siehe Detail ① (Rückseite).
- **IP40 gilt nur in Verbindung mit montiertem Acrylglasprofil.** Die thermische Längenausdehnung des Aluminiumprofils beträgt bei  $dT = 10$  Kelvin  $0.3$  mm pro Meter.
- **Einbaulänge:** Profillänge +  $2 \times 3$  mm (Enddeckelstärke)  
**Ausschnitt:** (Einbaulänge +  $2$  mm) x  $74$  mm  
**Einbautiefe:**  $100$  mm  
**Deckenstärke:**  $6 - 25$  mm  
**Spannbügelweite:** max.  $220$  mm

**GB**

- **Consider the following installation instructions and notes:**  
818278 general notes for LED luminaires  
827473 installation instruction for AOV shielding foil ⑧  
Consider the enclosed installation instructions for connectors, concrete and trimless mounting. Recessed mounting see detail ① (on the back).
- **IP40 only applies in with mounted acrylic glass profile.** The linear thermal expansion of the aluminium profile is about  $0.3$  mm per meter at  $dT = 10$  Kelvin.
- **Recessed length:** profile length +  $2 \times 3$  mm (thickness of end covers)  
**Cut-out:** (recessed length +  $2$  mm) x  $74$  mm  
**Installation depth:**  $100$  mm  
**Ceiling thickness:**  $6 - 25$  mm  
**Required clamps space:** max.  $220$  mm

