

# CSALP 50.2027.15/DALI



## Description

- recessed spotlight with conical light-head
- suitable for lighting of vertical surfaces
- luminaire rotates through 350° and light-head pivots out through 35°
- outstanding ease of maintenance
- no UV and thermal emissions
- thermal management with passive cooling (heat sink made from aluminium)
- specular aluminium reflector with precise symmetrical beam characteristic for high luminous efficiency and glare-free lighting
- front/recessed ring and light-head made from die-cast zinc
- clear safety glass
- tool-free ceiling mounting via quick-action clamping springs (automatic adjustment of the ceiling thickness)
- luminaire and ballast permanently connected via cable (length: 500 mm), ballast ready for mains connection
- ballast (LED converter DALI, dimmable) included (external placement)

## Standard options



## Special options



Colours	Article no.	EAN
black	643456	4043544496621
silver	643457	4043544496638
white	643458	4043544496645

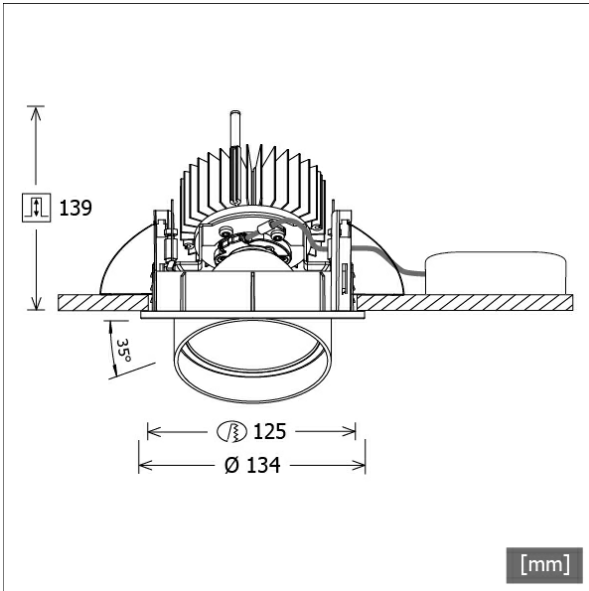

## Lighting data / Norms

<b>Lamps</b>	LED Spot / CRI 80 / 2700 K
<b>EPREL light sources</b>	848120
<b>Lifetime</b>	L90 B50 50.000 h L80 B50 100.000 h L80 B20 50.000 h
<b>System power</b>	27.0 W
<b>Luminaire luminous flux</b>	2580 lm
<b>System efficiency</b>	95.55 lm/W
<b>Module efficiency</b>	127.18 lm/W
<b>UGR class</b>	≤19
<b>Beam angle</b>	15°
<b>Supply voltage</b>	220 - 240 V / 50 - 60 Hz
<b>Protection class</b>	II
<b>Type of protection</b>	IP20

## Dimensions / Weights

<b>Outer diameter</b>	134 mm
<b>Height</b>	144 mm
<b>Cut-out (Ø)</b>	125 mm
<b>Ceiling thickness</b>	1.0 - 25.0 mm
<b>Recessed depth</b>	139 mm
<b>Net weight</b>	1.25 kg
<b>Gross weight</b>	1.33 kg



# CSALP 50.2027.15/DALI

CSA 50 (1xLED 27W 827/2700K 2580lm 15 °)

C0/C180 cd / 1000 lm

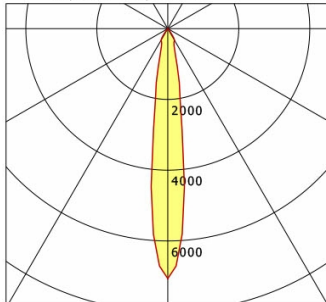

	C0	C90	C180	C270
0°	7062	7062	7062	7062
15°	931	931	931	931
30°	375	375	375	375
45°	12	12	12	12
60°	12	12	12	12
75°	3	3	3	3
90°	0	0	0	0
cd / 1000 lm				

Offset [m] Cone width [m] Illuminance [lx]

Offset [m]	Cone width [m]	Illuminance [lx]
3.0	0.75	2024.5
6.0	1.49	506.1
9.0	2.24	224.9
12.0	2.99	126.5
15.0	3.73	81.0

<b>η</b>	LED
Efficiency	96 lm/W
Direct/Indirect	↓ 100% / ↑ 0%
System Power	27 W
<b>UGR</b>	X=4H, Y=8H
Reflection factors	70/50/20
UGR C0/C180	18.9
UGR C90/C270	18.9
CIE Flux Codes	97 99 100 100 100
Ra/CRI	>80

LTS

## Accessories



**ZB-OR DONGLE**  
Organic Response IR dongle kit



**ZB-OR GATEWAY**  
Organic Response IoT Gateway Cascade Series



**ZB-OR-R SENSOR**  
Organic Response sensor for recessed mounting



**ZDAR 125.145-205**  
compensation ring for ceiling cut-outs from 145 to 205 mm