

CSALP 60.3030.15



Colours	Article no.	EAN
black	637284	4043544399908
silver	637285	4043544399915
white	637286	4043544399922



Description

- recessed spotlight with wide range of applications
- luminaire rotates through 350° and pivots through 40°
- outstanding ease of maintenance
- no UV and thermal emissions
- thermal management with passive cooling (heat sink made from aluminium)
- specular aluminium reflector with precise symmetrical beam characteristic for high luminous efficiency and glare-free lighting
- front rings and recessed ring made from die-cast zinc
- tool-free ceiling mounting via quick-action clamping springs (automatic adjustment of the ceiling thickness)
- luminaire and ballast permanently connected via cable (length: 500 mm), ballast ready for mains connection
- ballast (LED converter) included (external placement)

Standard options



Special options



Lighting data / Norms

Lamps	LED Spot / CRI 80 / 3000 K
EPREL light sources	851239
Lifetime	L90 B50 50.000 h
	L80 B50 100.000 h
	L80 B20 50.000 h
System power	36.0 W
Luminaire luminous flux	3640 lm
System efficiency	101.11 lm/W
Module efficiency	158.91 lm/W
UGR class	≤22
Beam angle	15°
Supply voltage	220 - 240 V / 50 - 60 Hz
Protection class	II
Type of protection	IP20

Dimensions / Weights

Outer diameter	134 mm
Height	118 mm
Cut-out (Ø)	125 mm
Ceiling thickness	1.0 - 25.0 mm
Recessed depth	130 mm
Net weight	1.12 kg
Gross weight	1.22 kg

CSALP 60.3030.15

CSA 60 (1xLED 36W 830/3000K 3640lm 15 °)

C0/C180 cd / 1000 lm

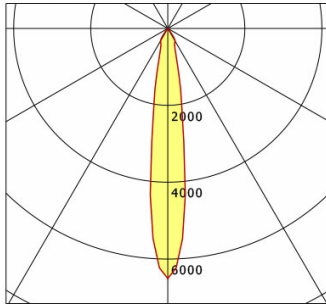

	C0	C90	C180	C270
0°	6506	6506	6506	6506
15°	966	966	966	966
30°	380	380	380	380
45°	4	4	4	4
60°	4	4	4	4
75°	2	2	2	2
90°	0	0	0	0
cd / 1000 lm				

Offset [m] Cone width [m] Illuminance [lx]

Offset [m]	Cone width [m]	Illuminance [lx]
3.0	0.79	2631.2
6.0	1.59	657.8
9.0	2.38	292.4
12.0	3.17	164.5
15.0	3.96	105.2

η	LED
Efficiency	101 lm/W
Direct/Indirect	↓ 100% / ↑ 0%
System Power	36 W
UGR	X=4H, Y=8H
Reflection factors	70/50/20
UGR C0/C180	19.9
UGR C90/C270	19.9
CIE Flux Codes	99 99 100 100 100
Ra/CRI	>80

LTS

Accessories



ZDAR 125.145-205
compensation ring for ceiling cut-outs from 145 to 205 mm