

CSALP 50.1030.35



Description

- recessed spotlight with conical light-head
- suitable for lighting of vertical surfaces
- luminaire rotates through 350° and light-head pivots out through 35°
- outstanding ease of maintenance
- no UV and thermal emissions
- thermal management with passive cooling (heat sink made from aluminium)
- specular aluminium reflector with precise symmetrical beam characteristic for high luminous efficiency and glare-free lighting
- front/recessed ring and light-head made from die-cast zinc
- clear safety glass
- tool-free ceiling mounting via quick-action clamping springs (automatic adjustment of the ceiling thickness)
- luminaire and ballast permanently connected via cable (length: 500 mm), ballast ready for mains connection
- ballast (LED converter) included (external placement)

Standard options

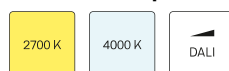

Special options



Colours	Article no.	EAN
black	643417	4043544496232
silver	643418	4043544496249
white	643419	4043544496256

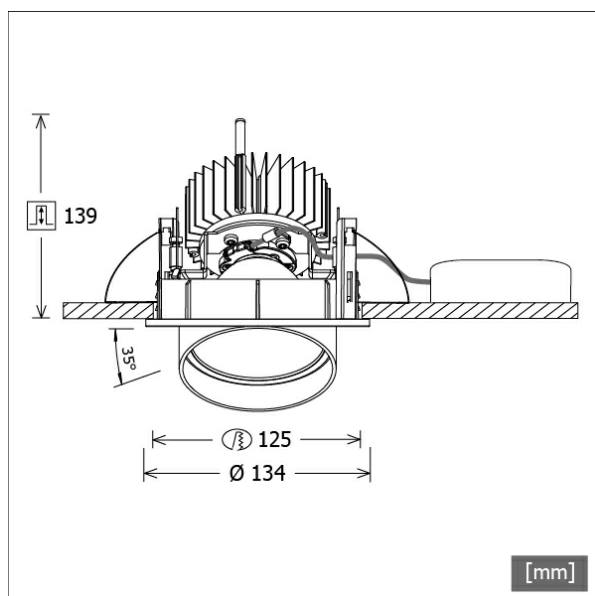

Lighting data / Norms

Lamps	LED Spot / CRI 80 / 3000 K
EPREL light sources	848117
	L90 B50 50.000 h
	L80 B50 100.000 h
	L80 B20 50.000 h
Lifetime	
System power	14.0 W
Luminaire luminous flux	1390 lm
System efficiency	99.28 lm/W
Module efficiency	156.64 lm/W
UGR class	≤19
Beam angle	35°
Supply voltage	220 - 240 V / 50 - 60 Hz
Protection class	II
Type of protection	IP20

Dimensions / Weights

Outer diameter	134 mm
Height	144 mm
Cut-out (Ø)	125 mm
Ceiling thickness	1.0 - 25.0 mm
Recessed depth	139 mm
Net weight	1.17 kg
Gross weight	1.23 kg



CSALP 50.1030.35

CSA 50 (1xLED 14W 830/3000K 1390lm 35 °)

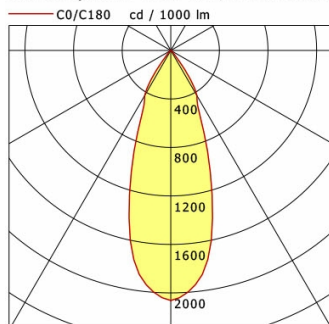

	C0	C90	C180	C270
0°	2063	2063	2063	2063
15°	1327	1327	1327	1327
30°	430	430	430	430
45°	21	21	21	21
60°	8	8	8	8
75°	4	4	4	4
90°	0	0	0	0
cd / 1000 lm				

Offset [m]	Cone width [m]	Illuminance [lx]
3.0	1.98	318.6
6.0	3.96	79.6
9.0	5.94	35.4
12.0	7.91	19.9
15.0	9.89	12.7

η	LED
Efficiency	99 lm/W
Direct/Indirect	↓ 100% / ↑ 0%
System Power	14 W
UGR	X=4H, Y=8H
Reflection factors	70/50/20
UGR C0/C180	18.4
UGR C90/C270	18.4
CIE Flux Codes	96 99 100 100 100
Ra/CRI	>80

LTS

Accessories



ZDAR 125.145-205
compensation ring for ceiling cut-outs from 145 to 205 mm