

# FLIQ 100.1027.01

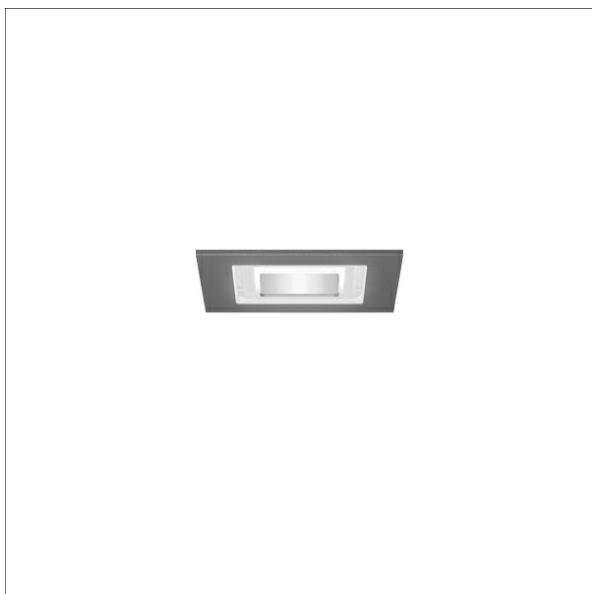

Colours	Article no.	EAN
black	647585	4043544548191
silver	647586	4043544548207
white	647587	4043544548214

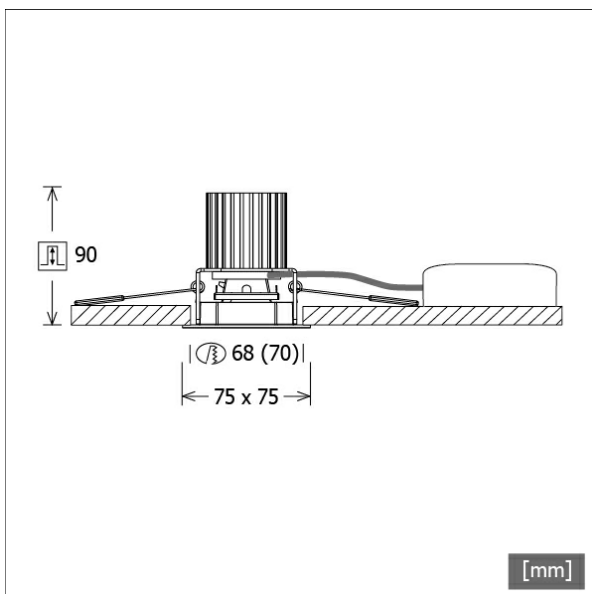

## Description

- recessed spotlight with optical design variants for general lighting
- outstanding ease of maintenance
- no UV and thermal emissions
- innovative thermal management with passive cooling (heat sink made from aluminium)
- non-reflective matt aluminium reflector for highest luminous efficiency and best glare-free lighting
- front/recessed frame made from die-cast zinc with clear light effect frame (other decor/light effect frames and deco glasses are available as options)
- tool-free ceiling mounting via quick-action clamping springs (automatic adjustment of the ceiling thickness)
- luminaire and ballast permanently connected via cable (length: 500 mm), ballast ready for mains connection
- ballast (LED converter) included (external placement)

## Notes

The cut-out = 68 mm is only valid for plasterboard ceilings. For other types of ceilings the cut-out = 70 mm.

## Standard options

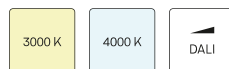

## Special options



## Lighting data / Norms

Lamps	LED Spot / CRI 80 / 2700 K
EPREL light sources	988874
Lifetime	L90 B50 50.000 h
	L80 B50 100.000 h
	L80 B20 50.000 h
System power	15.0 W
Luminaire luminous flux	max. 1110 lm
System efficiency	64.00 lm/W
Module efficiency	128.77 lm/W
UGR class	>28
Beam angle	65°
Supply voltage	220 - 240 V / 50 - 60 Hz
Protection class	II
Type of protection	IP20

## Dimensions / Weights

Length	75 mm
Width	75 mm
Height	92 mm
Cut-out (Ø)	68 mm
Ceiling thickness	1.0 - 25.0 mm
Recessed depth	90 mm
Net weight	0.58 kg
Gross weight	0.61 kg

# FLIQ 100.1027.01

## FLIQ 100.1027.01

Flixx 100 Square (FLIQZ 100.24, 1xLED 15W 827/2700K 960lm 65°)

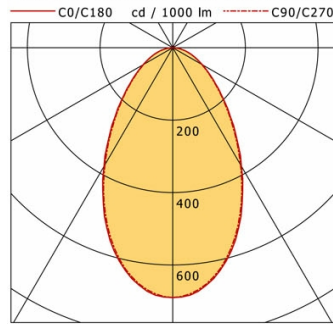

	C0	C90	C180	C270
0°	690	690	690	690
15°	596	591	596	591
30°	378	374	378	374
45°	194	191	194	191
60°	94	92	94	92
75°	39	37	39	37
90°	1	1	1	1
cd / 1000 lm				

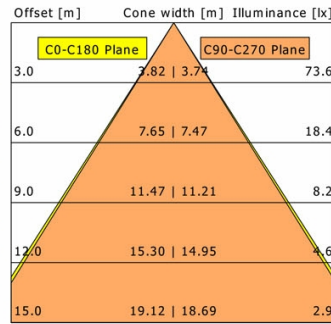

<b>η</b>	LED
Efficiency	64 lm/W
Direct/Indirect	↓ 100% / ↑ 0%
System Power	15 W
<b>UGR</b>	X=4H, Y=8H
Reflection factors	70/50/20
UGR C0/C180	31.4
UGR C90/C270	31.3
CIE Flux Codes	65 88 97 100 100
Ra/CRI	>80

LTS

## FLIQ 100.1027.01

Flixx 100 Square (FLIQZ 100.25, 1xLED 15W 827/2700K 1060lm 65°)

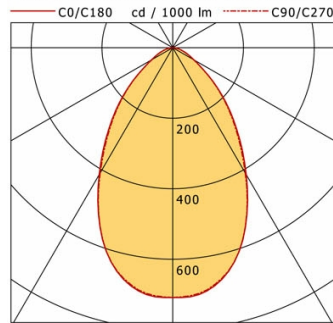

	C0	C90	C180	C270
0°	709	709	709	709
15°	643	642	643	642
30°	416	410	416	410
45°	205	201	205	201
60°	69	68	69	68
75°	24	24	24	24
90°	0	0	0	0
cd / 1000 lm				

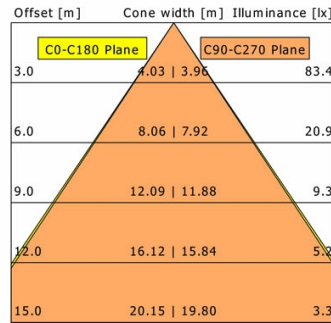

<b>η</b>	LED
Efficiency	71 lm/W
Direct/Indirect	↓ 100% / ↑ 0%
System Power	15 W
<b>UGR</b>	X=4H, Y=8H
Reflection factors	70/50/20
UGR C0/C180	29.6
UGR C90/C270	29.7
CIE Flux Codes	71 92 99 100 100
Ra/CRI	>80

LTS

## FLIQ 100.1027.01

Flixx 100 Square (FLIQZ 100.05, 1xLED 15W 827/2700K 1110lm 65°)

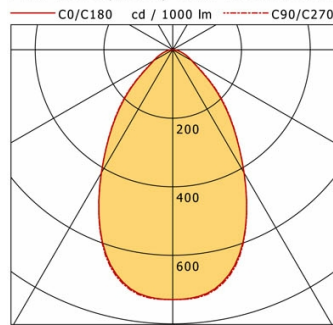

	C0	C90	C180	C270
0°	729	729	729	729
15°	666	670	666	670
30°	415	415	415	415
45°	193	199	193	199
60°	64	65	64	65
75°	23	24	23	24
90°	0	0	0	0
cd / 1000 lm				

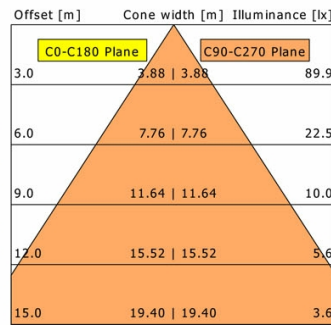

<b>η</b>	LED
Efficiency	74 lm/W
Direct/Indirect	↓ 100% / ↑ 0%
System Power	15 W
<b>UGR</b>	X=4H, Y=8H
Reflection factors	70/50/20
UGR C0/C180	29.4
UGR C90/C270	29.6
CIE Flux Codes	73 93 99 100 100
Ra/CRI	>80

LTS

# FLIQ 100.1027.01

## Accessories



**FLIQZ 100.01**  
decorative frame black



**FLIQZ 100.02**  
decorative frame silver



**FLIQZ 100.03**  
decorative frame white



**FLIQZ 100.04**  
light effect frame opal



**FLIQZ 100.05**  
light effect frame clear



**FLIQZ 100.06**  
light effect frame red matt



**FLIQZ 100.07**  
light effect frame yellow matt



**FLIQZ 100.08**  
light effect frame blue matt



**FLIQZ 100.16**  
light effect frame red translucent



**FLIQZ 100.17**  
light effect frame yellow translucent



**FLIQZ 100.18**  
light effect frame blue translucent



**FLIQZ 100.24**  
decorative glass opal



**FLIQZ 100.25**  
decorative glass clear