

FLIQ 400.3030.01

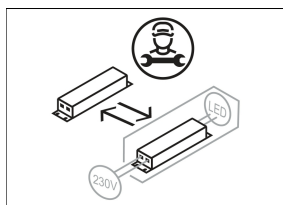

Colours	Article no.	EAN
black	636483	4043544390653
silver	636484	4043544390660
white	636485	4043544390677

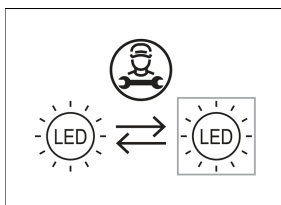
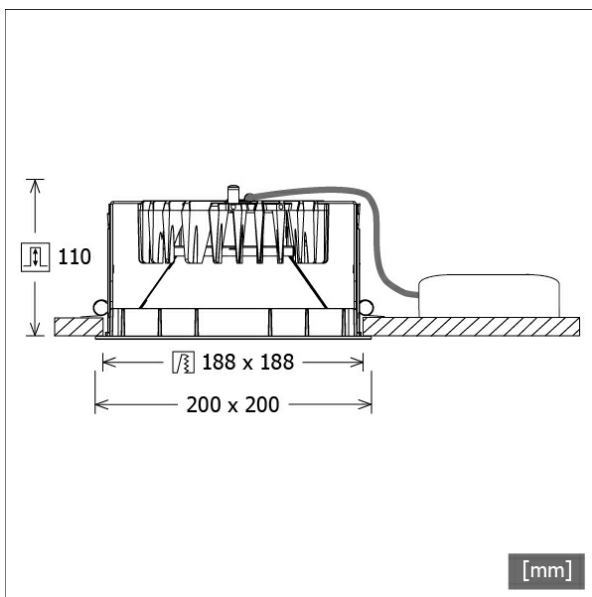

Description

- recessed spotlight with optical design variants for general lighting
- outstanding ease of maintenance
- no UV and thermal emissions
- innovative thermal management with passive cooling (heat sink made from die-cast aluminium)
- non-reflective matt aluminium reflector for highest luminous efficiency and best glare-free lighting
- front/recessed frame made from die-cast zinc with clear light effect frame (other decor/light effect frames and deco glasses are available as options)
- tool-free ceiling mounting via automatic quick clamping (automatic adjustment of the ceiling thickness)
- luminaire and ballast permanently connected via cable (length: 500 mm), ballast ready for mains connection
- ballast (LED converter) included (external placement)

Standard options



Special options



Lighting data / Norms

Lamps	LED Modul / CRI 80 / 3000 K
EPREL light sources	891012
Lifetime	L90 B50 50.000 h L80 B50 100.000 h L80 B20 50.000 h
System power	26.0 W
Luminaire luminous flux	max. 3240 lm
System efficiency	124.61 lm/W
Module efficiency	167.99 lm/W
UGR class	≤25
Supply voltage	220 - 240 V / 50 - 60 Hz
Protection class	II
Type of protection	IP20

Dimensions / Weights

Length	200 mm
Width	200 mm
Height	112 mm
Cut-out (LxW)	188 x 188 mm
Ceiling thickness	5.0 - 50.0 mm
Recessed depth	110 mm
Net weight	1.21 kg
Gross weight	1.27 kg

FLIQ 400.3030.01

Flixx 400 Square (FLIQZ 400.05, 1xLED 26W 830/3000K 3240lm)

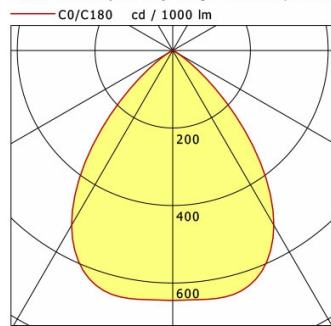

	C0	C90	C180	C270
0°	645	645	645	645
15°	647	647	647	647
30°	521	521	521	521
45°	209	209	209	209
60°	17	17	17	17
75°	4	4	4	4
90°	0	0	0	0

cd / 1000 lm

Offset [m]	Cone width [m]	Illuminance [lx]
3.0	5.01	232.2
6.0	10.01	58.1
9.0	15.02	25.8
12.0	20.03	14.5
15.0	25.03	9.3

η	LED
Efficiency	125 lm/W
Direct/Indirect	↓ 100% / ↑ 0%
System Power	26 W
UGR	X=4H, Y=8H
Reflection factors	70/50/20
UGR C0/C180	20.9
UGR C90/C270	20.9
CIE Flux Codes	81 99 100 100 100
Ra/CRI	>80

LTS

Flixx 400 Square (FLIQZ 400.24, 1xLED 26W 830/3000K 3100lm)

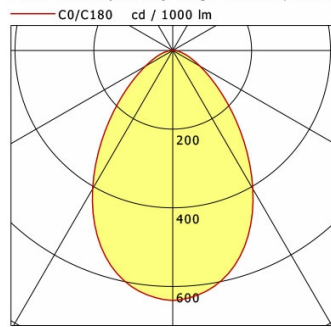

	C0	C90	C180	C270
0°	636	636	636	636
15°	577	577	577	577
30°	406	406	406	406
45°	204	204	204	204
60°	80	80	80	80
75°	27	27	27	27
90°	0	0	0	0

cd / 1000 lm

Offset [m]	Cone width [m]	Illuminance [lx]
3.0	4.40	218.9
6.0	8.80	54.7
9.0	13.19	24.3
12.0	17.59	13.7
15.0	21.99	8.8

η	LED
Efficiency	119 lm/W
Direct/Indirect	↓ 100% / ↑ 0%
System Power	26 W
UGR	X=4H, Y=8H
Reflection factors	70/50/20
UGR C0/C180	24.6
UGR C90/C270	24.6
CIE Flux Codes	67 91 98 100 100
Ra/CRI	>80

LTS

Flixx 400 Square (FLIQZ 400.25, 1xLED 26W 830/3000K 3170lm)

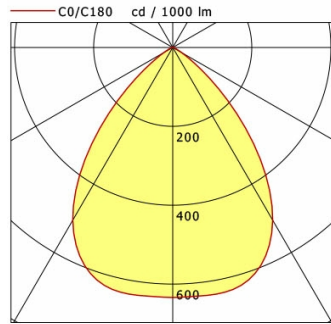

	C0	C90	C180	C270
0°	634	634	634	634
15°	630	630	630	630
30°	506	506	506	506
45°	213	213	213	213
60°	26	26	26	26
75°	5	5	5	5
90°	0	0	0	0

cd / 1000 lm

Offset [m]	Cone width [m]	Illuminance [lx]
3.0	5.04	223.3
6.0	10.08	55.8
9.0	15.12	24.8
12.0	20.16	14.0
15.0	25.19	8.9

η	LED
Efficiency	122 lm/W
Direct/Indirect	↓ 100% / ↑ 0%
System Power	26 W
UGR	X=4H, Y=8H
Reflection factors	70/50/20
UGR C0/C180	21.1
UGR C90/C270	21.1
CIE Flux Codes	79 98 100 100 100
Ra/CRI	>80

LTS

FLIQ 400.3030.01

Accessories



FLIQZ 400.01
decorative frame black

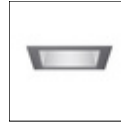

FLIQZ 400.02
decorative frame silver



FLIQZ 400.03
decorative frame white



FLIQZ 400.04
light effect frame opal



FLIQZ 400.05
light effect frame clear



FLIQZ 400.06
light effect frame red matt



FLIQZ 400.07
light effect frame yellow matt



FLIQZ 400.08
light effect frame blue matt



FLIQZ 400.16
light effect frame red translucent



FLIQZ 400.17
light effect frame yellow translucent



FLIQZ 400.18
light effect frame blue translucent



FLIQZ 400.24
decorative glass opal



FLIQZ 400.25
decorative glass clear



NOL 50B/3H/DALI
LED emergency light-unit



ZVP 100
universal reinforcement frame
(module 625 x 625)