

SCEKLP 10.2040.15

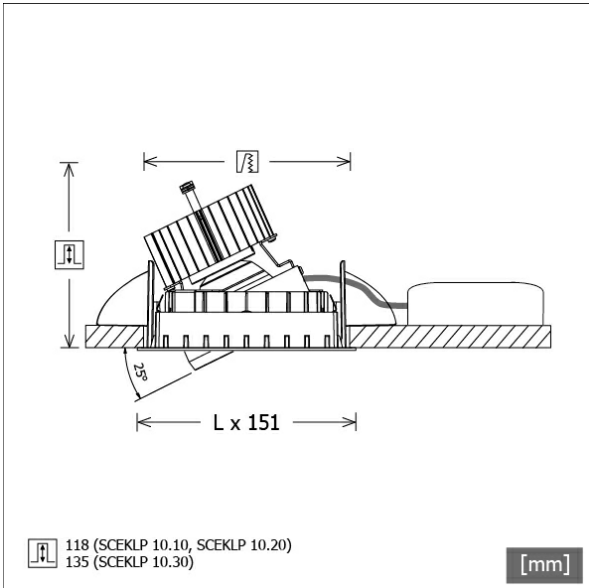

Colours	Article no.	EAN
black	637151	4043544398062
silver	637152	4043544398079
white	637153	4043544398086



Description

- flexible recessed spotlight system consisting of recessed frames, light-heads and ballasts (recessed frames to be ordered separately)
- adjustable ceiling look: flush with ceiling or recessed by 6 mm
- light-head rotates through 350° and pivots through 25°
- outstanding ease of maintenance
- no UV and thermal emissions
- light-head consisting of front frame (die-cast magnesium) and front ring (die-cast zinc)
- thermal management with passive cooling (heat sink made from aluminium)
- specular aluminium reflector with precise symmetrical beam characteristic for high luminous efficiency and glare-free lighting
- light-head snaps into mounting frame without tools
- connection to ballast via luminaire cable with Mini-Clamp connector
- ballast (LED converter) included (external placement)

Standard options



Special options

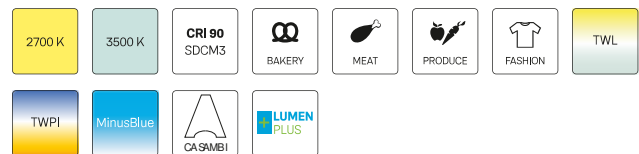

Lighting data / Norms

Lamps	LED Spot / CRI 80 / 4000 K
EPREL light sources	848119
Lifetime	L90 B50 50.000 h
	L80 B50 100.000 h
	L80 B20 50.000 h
System power	25.8 W
Luminaire luminous flux	2880 lm
System efficiency	111.62 lm/W
Module efficiency	160.37 lm/W
UGR class	≤19
Beam range	Spot
Beam angle	15°
Supply voltage	220 - 240 V / 50 - 60 Hz
Protection class	III
Type of protection	IP20

Dimensions / Weights

Length	125 mm
Width	125 mm
Height	121 mm
Recessed depth	118 mm
Diameter of light head	100 mm
Net weight	0.90 kg
Gross weight	0.95 kg

SCEKLP 10.2040.15

SCEKLP 10.2040.15

Scene 1 System | Light-Head (1xLED 26W 840/4000K 2880lm)

— C0/C180 cd / 1000 lm

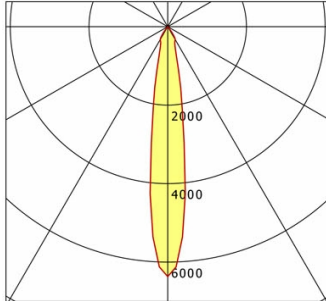

	C0	C90	C180	C270
0°	6368	6368	6368	6368
15°	959	959	959	959
30°	383	383	383	383
45°	4	4	4	4
60°	4	4	4	4
75°	2	2	2	2
90°	0	0	0	0
cd / 1000 lm				

Offset [m] Cone width [m] Illuminance [lx]

Offset [m]	Cone width [m]	Illuminance [lx]
3.0	0.81	2037.7
6.0	1.62	509.4
9.0	2.42	226.4
12.0	3.23	127.4
15.0	4.04	81.5

η	LED
Efficiency	111 lm/W
Direct/Indirect	↓ 100% / ↑ 0%
System Power	26 W
UGR	X=4H, Y=8H
Reflection factors	70/50/20
UGR C0/C180	19.1
UGR C90/C270	19.1
CIE Flux Codes	99 99 100 100 100
Ra/CRI	>80

LTS

Accessories



SCER 1.100
mounting frame 1-lamp



SCER 1.200
mounting frame 2-lamp



SCER 1.300
mounting frame 3-lamp