

SCEKLP 10.2030.15/DALI

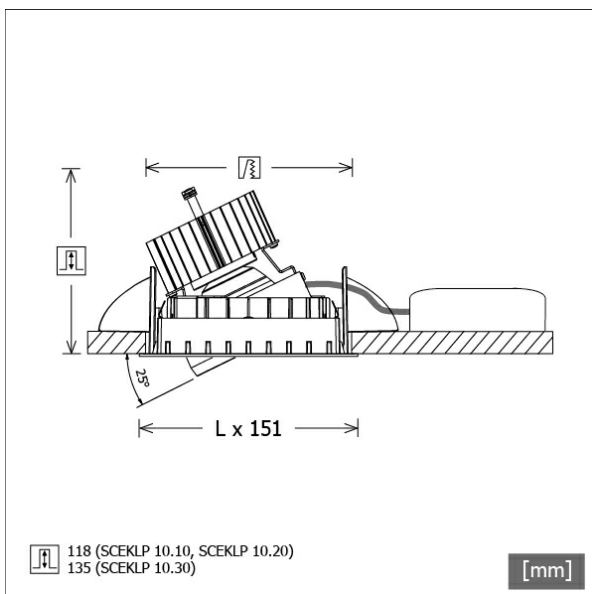

Colours	Article no.	EAN
black	644056	4043544502834
silver	644057	4043544502841
white	644058	4043544502858



Description

- flexible recessed spotlight system consisting of recessed frames, light-heads and ballasts (recessed frames to be ordered separately)
- adjustable ceiling look: flush with ceiling or recessed by 6 mm
- light-head rotates through 350° and pivots through 25°
- outstanding ease of maintenance
- no UV and thermal emissions
- light-head consisting of front frame (die-cast magnesium) and front ring (die-cast zinc)
- thermal management with passive cooling (heat sink made from aluminium)
- specular aluminium reflector with precise symmetrical beam characteristic for high luminous efficiency and glare-free lighting
- light-head snaps into mounting frame without tools
- connection to ballast via luminaire cable with Mini-Clamp connector
- ballast (LED converter DALI, dimmable) included (external placement)

Standard options



Special options

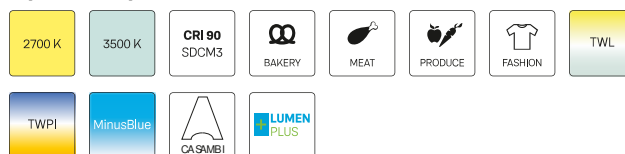

Lighting data / Norms

Lamps	LED Spot / CRI 80 / 3000 K
EPREL light sources	848117
Lifetime	L90 B50 50.000 h
	L80 B50 100.000 h
	L80 B20 50.000 h
System power	25.8 W
Luminaire luminous flux	2740 lm
System efficiency	106.20 lm/W
Module efficiency	156.64 lm/W
UGR class	≤19
Beam range	Spot
Beam angle	15°
Supply voltage	220 - 240 V / 50 - 60 Hz
Protection class	III
Type of protection	IP20

Dimensions / Weights

Length	125 mm
Width	125 mm
Height	121 mm
Recessed depth	118 mm
Diameter of light head	100 mm
Net weight	0.91 kg
Gross weight	0.96 kg

SCEKLP 10.2030.15/DALI

SCEKLP 10.2030.15/DALI

Scene 1 System | Light-Head (1xLED 26W 830/3000K 2740lm)

C0/C180 cd / 1000 lm

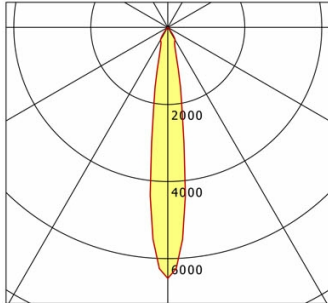

	C0	C90	C180	C270
0°	6512	6512	6512	6512
15°	967	967	967	967
30°	377	377	377	377
45°	4	4	4	4
60°	3	3	3	3
75°	2	2	2	2
90°	0	0	0	0
cd / 1000 lm				

Offset [m] Cone width [m] Illuminance [lx]

Offset [m]	Cone width [m]	Illuminance [lx]
3.0	0.80	1982.4
6.0	1.60	495.6
9.0	2.40	220.3
12.0	3.20	123.9
15.0	4.00	79.3

η	LED
Efficiency	106 lm/W
Direct/Indirect	↓ 100% / ↑ 0%
System Power	26 W
UGR	X=4H, Y=8H
Reflection factors	70/50/20
UGR C0/C180	18.8
UGR C90/C270	18.8
CIE Flux Codes	99 100 100 100 100
Ra/CRI	>80

LTS

Accessories



SCER 1.100
mounting frame 1-lamp



SCER 1.200
mounting frame 2-lamp



SCER 1.300
mounting frame 3-lamp



ZB-OR DONGLE
Organic Response IR dongle kit



ZB-OR GATEWAY
Organic Response IoT Gateway Cascade Series



ZB-OR-R SENSOR
Organic Response sensor for recessed mounting