

CSALP 60.1030.25



Description

- recessed spotlight with wide range of applications
- luminaire rotates through 350° and pivots through 40°
- outstanding ease of maintenance
- no UV and thermal emissions
- thermal management with passive cooling (heat sink made from aluminium)
- specular aluminium reflector with precise symmetrical beam characteristic for high luminous efficiency and glare-free lighting
- front rings and recessed ring made from die-cast zinc
- tool-free ceiling mounting via quick-action clamping springs (automatic adjustment of the ceiling thickness)
- luminaire and ballast permanently connected via cable (length: 500 mm), ballast ready for mains connection
- ballast (LED converter) included (external placement)

Standard options



Special options



Colours	Article no.	EAN
silver	612555	4043544290618
white	612556	4043544290625
black	637523	4043544411020

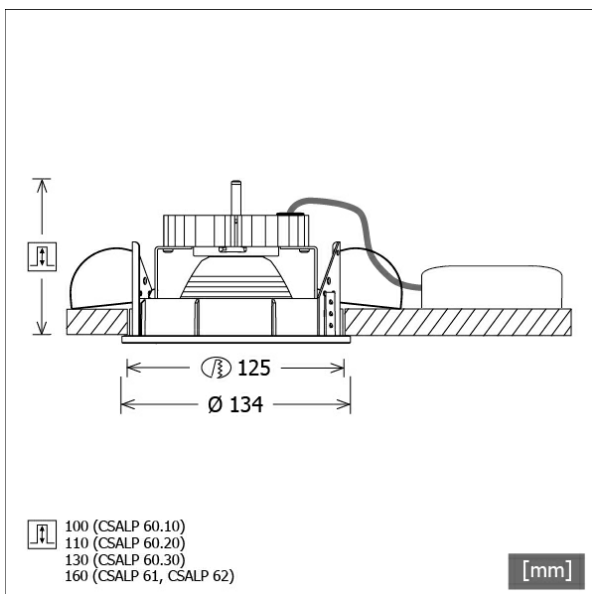

Lighting data / Norms

Lamps	LED Spot / CRI 80 / 3000 K
EPREL light sources	848117
	L90 B50 50.000 h
	L80 B50 100.000 h
	L80 B20 50.000 h
Lifetime	
System power	14.0 W
Luminaire luminous flux	1420 lm
System efficiency	101.42 lm/W
Module efficiency	156.64 lm/W
UGR class	≤19
Beam angle	25°
Supply voltage	220 - 240 V / 50 - 60 Hz
Protection class	II
Type of protection	IP20

Dimensions / Weights

Outer diameter	134 mm
Height	90 mm
Cut-out (Ø)	125 mm
Ceiling thickness	1.0 - 25.0 mm
Recessed depth	100 mm
Net weight	0.94 kg
Gross weight	0.99 kg



CSALP 60.1030.25

CSA 60 (1xLED 14W 830/3000K 1420lm 25 °)

C0/C180 cd / 1000 lm

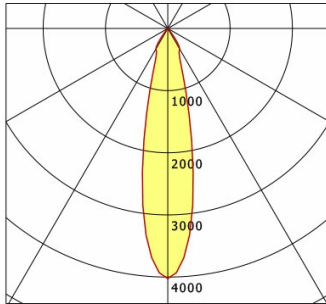

	C0	C90	C180	C270
0°	4023	4023	4023	4023
15°	1214	1214	1214	1214
30°	381	381	381	381
45°	7	7	7	7
60°	2	2	2	2
75°	2	2	2	2
90°	0	0	0	0
cd / 1000 lm				

Offset [m] Cone width [m] Illuminance [lx]

Offset [m]	Cone width [m]	Illuminance [lx]
3.0	1.20	634.8
6.0	2.41	158.7
9.0	3.61	70.5
12.0	4.82	39.7
15.0	6.02	25.4

η	LED
Efficiency	102 lm/W
Direct/Indirect	↓ 100% / ↑ 0%
System Power	14 W
UGR	X=4H, Y=8H
Reflection factors	70/50/20
UGR C0/C180	17.0
UGR C90/C270	17.0
CIE Flux Codes	99 99 100 100 100
Ra/CRI	>80

LTS

Accessories



ZDAR 125.145-205
compensation ring for ceiling cut-outs from 145 to 205 mm