

CSALP 50.2040.25/DALI



Description

- recessed spotlight with conical light-head
- suitable for lighting of vertical surfaces
- luminaire rotates through 350° and light-head pivots out through 35°
- outstanding ease of maintenance
- no UV and thermal emissions
- thermal management with passive cooling (heat sink made from aluminium)
- specular aluminium reflector with precise symmetrical beam characteristic for high luminous efficiency and glare-free lighting
- front/recessed ring and light-head made from die-cast zinc
- clear safety glass
- tool-free ceiling mounting via quick-action clamping springs (automatic adjustment of the ceiling thickness)
- luminaire and ballast permanently connected via cable (length: 500 mm), ballast ready for mains connection
- ballast (LED converter DALI, dimmable) included (external placement)

Standard options

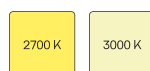

Colours	Article no.	EAN
black	643510	4043544497161
silver	643511	4043544497178
white	643512	4043544497185

Special options

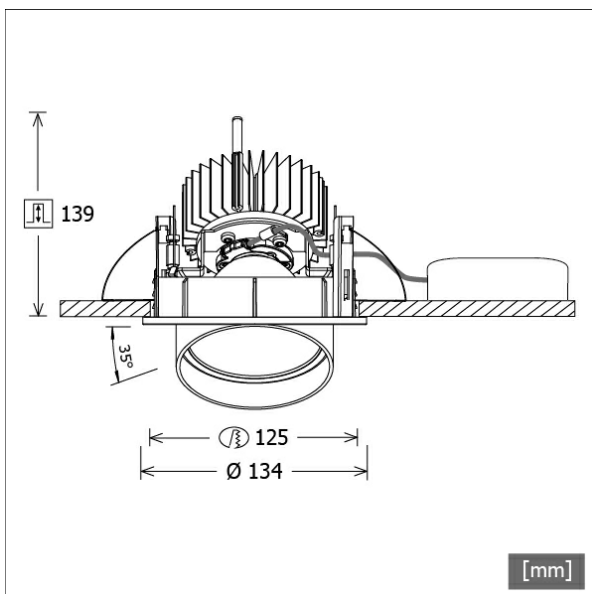

Lighting data / Norms

Lamps	LED Spot / CRI 80 / 4000 K
EPREL light sources	848119
	L90 B50 50.000 h
	L80 B50 100.000 h
	L80 B20 50.000 h
Lifetime	
System power	27.0 W
Luminaire luminous flux	2840 lm
System efficiency	105.18 lm/W
Module efficiency	160.37 lm/W
UGR class	≤19
Beam angle	25°
Supply voltage	220 - 240 V / 50 - 60 Hz
Protection class	II
Type of protection	IP20

Dimensions / Weights

Outer diameter	134 mm
Height	144 mm
Cut-out (Ø)	125 mm
Ceiling thickness	1.0 - 25.0 mm
Recessed depth	139 mm
Net weight	1.25 kg
Gross weight	1.33 kg



CSALP 50.2040.25/DALI

CSA 50 (1xLED 27W 840/4000K 2840lm 25 °)

C0/C180 cd / 1000 lm

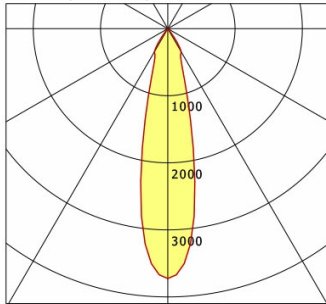

	C0	C90	C180	C270
0°	3726	3726	3726	3726
15°	1206	1206	1206	1206
30°	396	396	396	396
45°	11	11	11	11
60°	6	6	6	6
75°	3	3	3	3
90°	0	0	0	0
cd / 1000 lm				

Offset [m] Cone width [m] Illuminance [lx]

Offset [m]	Cone width [m]	Illuminance [lx]
3.0	1.26	1175.6
6.0	2.52	293.9
9.0	3.78	130.6
12.0	5.04	73.5
15.0	6.30	47.0

η	LED
Efficiency	105 lm/W
Direct/Indirect	↓ 100% / ↑ 0%
System Power	27 W
UGR	X=4H, Y=8H
Reflection factors	70/50/20
UGR C0/C180	19.4
UGR C90/C270	19.4
CIE Flux Codes	98 99 100 100 100
Ra/CRI	>80

LTS

Accessories



ZB-OR DONGLE
Organic Response IR dongle kit



ZB-OR GATEWAY
Organic Response IoT Gateway Cascade Series



ZB-OR-R SENSOR
Organic Response sensor for recessed mounting



ZDAR 125.145-205
compensation ring for ceiling cut-outs from 145 to 205 mm