

# CSALP 60.3030.15/DALI

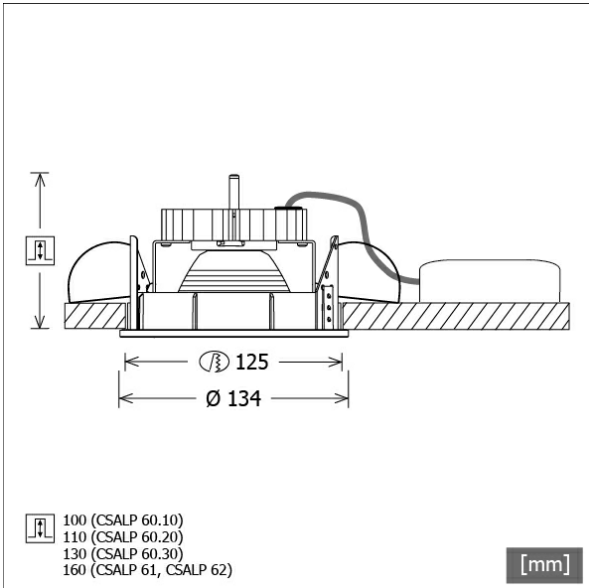

Colours	Article no.	EAN
black	643210	4043544494191
silver	643211	4043544494207
white	643212	4043544494214



## Description

- recessed spotlight with wide range of applications
- luminaire rotates through 350° and pivots through 40°
- outstanding ease of maintenance
- no UV and thermal emissions
- thermal management with passive cooling (heat sink made from aluminium)
- specular aluminium reflector with precise symmetrical beam characteristic for high luminous efficiency and glare-free lighting
- front rings and recessed ring made from die-cast zinc
- tool-free ceiling mounting via quick-action clamping springs (automatic adjustment of the ceiling thickness)
- luminaire and ballast permanently connected via cable (length: 500 mm), ballast ready for mains connection
- ballast (LED converter DALI, dimmable) included (external placement)

## Standard options



## Special options



## Lighting data / Norms

<b>Lamps</b>	LED Spot / CRI 80 / 3000 K
<b>EPREL light sources</b>	851239
	L90 B50 50.000 h
<b>Lifetime</b>	L80 B50 100.000 h
	L80 B20 50.000 h
<b>System power</b>	36.0 W
<b>Luminaire luminous flux</b>	3640 lm
<b>System efficiency</b>	101.11 lm/W
<b>Module efficiency</b>	158.91 lm/W
<b>UGR class</b>	≤22
<b>Beam angle</b>	15°
<b>Supply voltage</b>	220 - 240 V / 50 - 60 Hz
<b>Protection class</b>	II
<b>Type of protection</b>	IP20

## Dimensions / Weights

<b>Outer diameter</b>	134 mm
<b>Height</b>	118 mm
<b>Cut-out (Ø)</b>	125 mm
<b>Ceiling thickness</b>	1.0 - 25.0 mm
<b>Recessed depth</b>	130 mm
<b>Net weight</b>	1.18 kg
<b>Gross weight</b>	1.28 kg

# CSALP 60.3030.15/DALI

CSA 60 (1xLED 36W 830/3000K 3640lm 15 °)

C0/C180 cd / 1000 lm

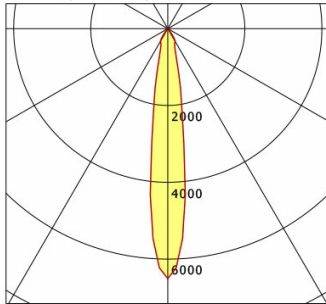

	C0	C90	C180	C270
0°	6506	6506	6506	6506
15°	966	966	966	966
30°	380	380	380	380
45°	4	4	4	4
60°	4	4	4	4
75°	2	2	2	2
90°	0	0	0	0
cd / 1000 lm				

Offset [m] Cone width [m] Illuminance [lx]

Offset [m]	Cone width [m]	Illuminance [lx]
3.0	0.79	2631.2
6.0	1.59	657.8
9.0	2.38	292.4
12.0	3.17	164.5
15.0	3.96	105.2

<b>η</b>	LED
Efficiency	101 lm/W
Direct/Indirect	↓ 100% / ↑ 0%
System Power	36 W
<b>UGR</b>	X=4H, Y=8H
Reflection factors	70/50/20
UGR C0/C180	19.9
UGR C90/C270	19.9
CIE Flux Codes	99 99 100 100 100
Ra/CRI	>80

LTS

## Accessories



**ZB-OR DONGLE**  
Organic Response IR dongle kit



**ZB-OR GATEWAY**  
Organic Response IoT Gateway Cascade Series



**ZB-OR-R SENSOR**  
Organic Response sensor for recessed mounting



**ZDAR 125.145-205**  
compensation ring for ceiling cut-outs from 145 to 205 mm