

LK-Z 060 AOV-K-002

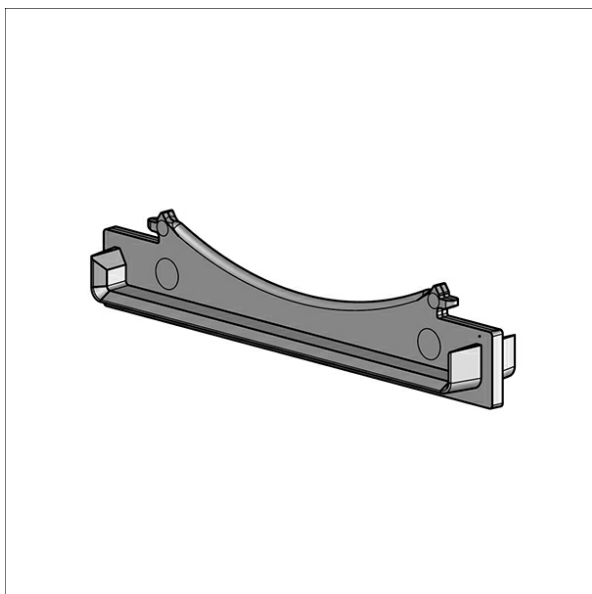

Description

- opal concealing unit protruding made from polycarbonate
- suitable for acrylic glass profile LK-Z 060 AOV-002/...
- tool-free snapping into Lichtkanal profile

Notes

To length = 3000 mm only one concealing unit is required. With lengths > 3000 mm for each 1500 mm one concealing unit is additionally required.

Dimensions / Weights

Length	2 mm
Width	69 mm
Height	10 mm
Net weight	0.01 kg
Gross weight	0.01 kg

Colours	Article no.	EAN
	662576	4043544716224