

CSALP 60.2027.15/DALI

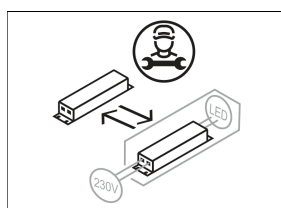

Colours	Article no.	EAN
black	643162	4043544493712
silver	643163	4043544493729
white	643164	4043544493736



Description

- recessed spotlight with wide range of applications
- luminaire rotates through 350° and pivots through 40°
- outstanding ease of maintenance
- no UV and thermal emissions
- thermal management with passive cooling (heat sink made from aluminium)
- specular aluminium reflector with precise symmetrical beam characteristic for high luminous efficiency and glare-free lighting
- front rings and recessed ring made from die-cast zinc
- tool-free ceiling mounting via quick-action clamping springs (automatic adjustment of the ceiling thickness)
- luminaire and ballast permanently connected via cable (length: 500 mm), ballast ready for mains connection
- ballast (LED converter DALI, dimmable) included (external placement)

Standard options



Special options

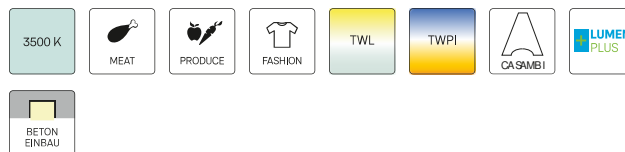

Lighting data / Norms

Lamps	LED Spot / CRI 80 / 2700 K
EPREL light sources	848120
	L90 B50 50.000 h
Lifetime	L80 B50 100.000 h
	L80 B20 50.000 h
System power	27.0 W
Luminaire luminous flux	2610 lm
System efficiency	96.66 lm/W
Module efficiency	127.18 lm/W
UGR class	≤19
Beam angle	15°
Supply voltage	220 - 240 V / 50 - 60 Hz
Protection class	II
Type of protection	IP20

Dimensions / Weights

Outer diameter	134 mm
Height	100 mm
Cut-out (Ø)	125 mm
Ceiling thickness	1.0 - 25.0 mm
Recessed depth	110 mm
Net weight	1.08 kg
Gross weight	1.14 kg

CSALP 60.2027.15/DALI

CSA 60 (1xLED 27W 827/2700K 2610lm 15 °)

C0/C180 cd / 1000 lm

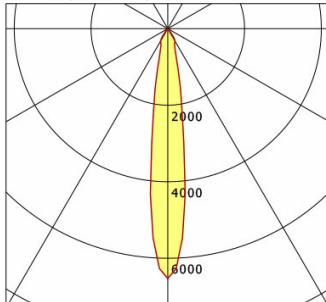

	C0	C90	C180	C270
0°	6530	6530	6530	6530
15°	959	959	959	959
30°	378	378	378	378
45°	5	5	5	5
60°	3	3	3	3
75°	2	2	2	2
90°	0	0	0	0
cd / 1000 lm				

Offset [m] Cone width [m] Illuminance [lx]

Offset [m]	Cone width [m]	Illuminance [lx]
3.0	0.79	1893.6
6.0	1.58	473.4
9.0	2.37	210.4
12.0	3.17	118.4
15.0	3.96	75.7

η	LED
Efficiency	97 lm/W
Direct/Indirect	↓ 100% / ↑ 0%
System Power	27 W
UGR	X=4H, Y=8H
Reflection factors	70/50/20
UGR C0/C180	18.7
UGR C90/C270	18.7
CIE Flux Codes	99 99 100 100 100
Ra/CRI	>80

LTS

Accessories



ZB-OR DONGLE
Organic Response IR dongle kit



ZB-OR GATEWAY
Organic Response IoT Gateway Cascade Series



ZB-OR-R SENSOR
Organic Response sensor for recessed mounting



ZDAR 125.145-205
compensation ring for ceiling cut-outs from 145 to 205 mm