

LK-L 060.10840.0985.U16/DALI



Description

- light-insert with integrated LED strips for 360° glare-free workplace lighting (UGR < 16)
- reflector made from traffic white painted aluminium sheet
- anti-glare collimators made from polycarbonate
- no UV and thermal emissions
- almost all strip light lengths can be realised
- 5-pole through-wiring kit included
- pMMA matt foil for uniform light distribution
- tool-free snapping into Lichtkanal profile via mounting springs
- 5-pole terminal block, pre-fabricated for through-wiring
- ballast (LED converter DALI, dimmable) integrated

Notes

Use only in conjunction with nanoOptix light-directing foils "deep beam" (STRL-LK060-Z 690.DB) and "batwing and wide beam" (STRL-LK060-Z 690.BW-WB). The linear thermal expansion of the aluminium profile is about 0.3 mm per meter at dT = 10 Kelvin.

Colours	Article no.	EAN
	667924	4043544795717

Standard options

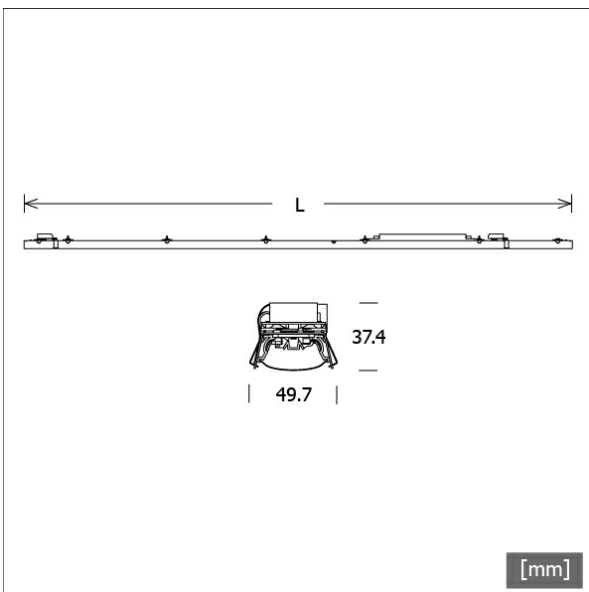

Lighting data / Norms

Lamps	LED linear / CRI 80 / 4000 K
Lifetime	L90 B50 50.000 h L80 B50 100.000 h L80 B20 50.000 h
System power	10.6 W
Luminaire luminous flux	max. 1540 lm
System efficiency	143.39 lm/W
Module efficiency	205.00 lm/W
UGR class	≤16
Supply voltage	220 - 240 V / 50 - 60 Hz
Protection class	I

Dimensions / Weights

Length	985 mm
Width	50 mm
Height	37 mm
Net weight	0.85 kg
Gross weight	0.89 kg

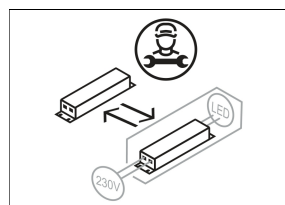
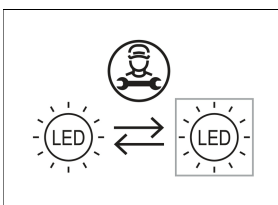

LK-L 060.10840.0985.U16/DALI

LK-L 060.10830.0985.U16/DALI

Lichtkanal 060 | Light-Insert (Deep Beam nanoOptix, 1xLED 11W 830/3000K 1440lm)

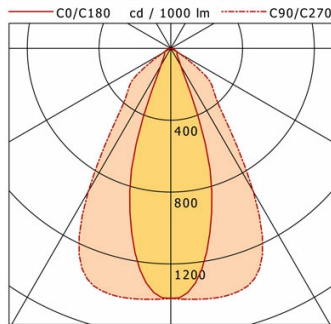

	C0	C90	C180	C270
0°	1392	1392	1392	1392
15°	886	1407	886	1407
30°	111	920	111	920
45°	50	340	50	340
60°	39	55	39	55
75°	17	7	17	7
90°	0	0	0	0

cd / 1000 lm

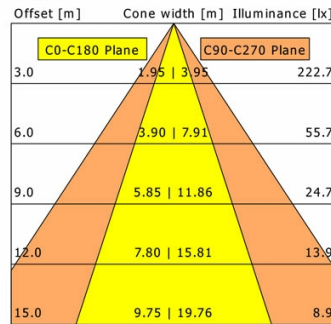

η	LED
Efficiency	131 lm/W
Direct/Indirect	↓ 100% / ↑ 0%
System Power	11 W
UGR	X=4H, Y=8H
Reflection factors	70/50/20
UGR C0/C180	14.5
UGR C90/C270	15.4
CIE Flux Codes	88 96 99 100 100
Ra/CRI	>80

LTS

LK-L 060.10830.0985.U16/DALI

Lichtkanal 060 | Light-Insert (Batwing/Wide Beam nanoOptix, 1xLED 11W 830/3000K 1460lm)

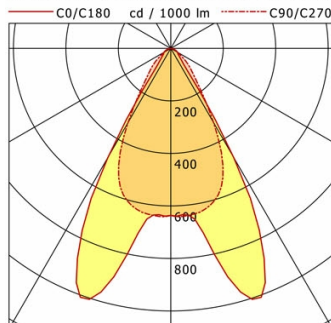

	C0	C90	C180	C270
0°	636	636	636	636
15°	934	611	934	611
30°	479	327	479	327
45°	50	104	50	104
60°	30	28	30	28
75°	14	9	14	9
90°	0	0	0	0

cd / 1000 lm

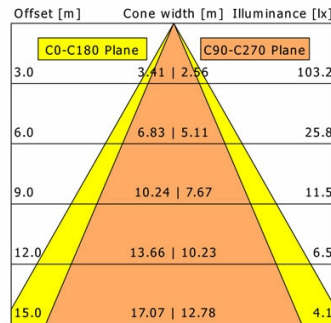

η	LED
Efficiency	133 lm/W
Direct/Indirect	↓ 100% / ↑ 0%
System Power	11 W
UGR	X=4H, Y=8H
Reflection factors	70/50/20
UGR C0/C180	14.2
UGR C90/C270	16.2
CIE Flux Codes	86 97 99 100 100
Ra/CRI	>80

LTS