

CSALP 50.2027.35/DALI



Description

- recessed spotlight with conical light-head
- suitable for lighting of vertical surfaces
- luminaire rotates through 350° and light-head pivots out through 35°
- outstanding ease of maintenance
- no UV and thermal emissions
- thermal management with passive cooling (heat sink made from aluminium)
- specular aluminium reflector with precise symmetrical beam characteristic for high luminous efficiency and glare-free lighting
- front/recessed ring and light-head made from die-cast zinc
- clear safety glass
- tool-free ceiling mounting via quick-action clamping springs (automatic adjustment of the ceiling thickness)
- luminaire and ballast permanently connected via cable (length: 500 mm), ballast ready for mains connection
- ballast (LED converter DALI, dimmable) included (external placement)

Standard options



Special options



Colours	Article no.	EAN
black	643468	4043544496744
silver	643469	4043544496751
white	643470	4043544496768

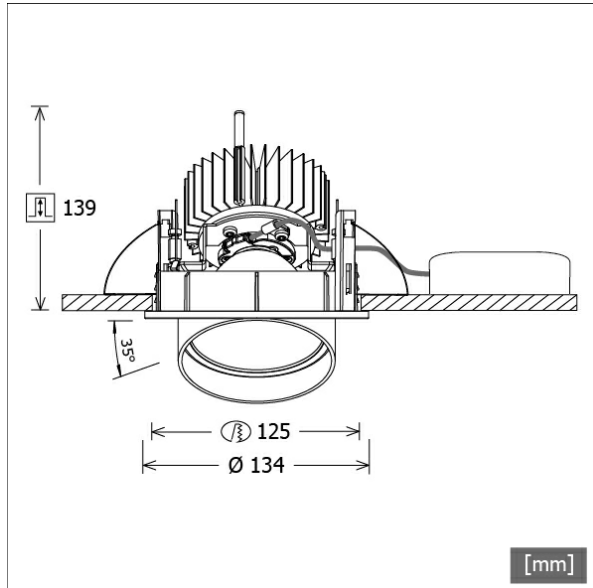

Lighting data / Norms

Lamps	LED Spot / CRI 80 / 2700 K
EPREL light sources	848120
Lifetime	L90 B50 50.000 h L80 B50 100.000 h L80 B20 50.000 h
System power	27.0 W
Luminaire luminous flux	2550 lm
System efficiency	94.44 lm/W
Module efficiency	127.18 lm/W
UGR class	≤22
Beam angle	35°
Supply voltage	220 - 240 V / 50 - 60 Hz
Protection class	II
Type of protection	IP20

Dimensions / Weights

Outer diameter	134 mm
Height	144 mm
Cut-out (Ø)	125 mm
Ceiling thickness	1.0 - 25.0 mm
Recessed depth	139 mm
Net weight	1.25 kg
Gross weight	1.33 kg



CSALP 50.2027.35/DALI

CSA 50 (1xLED 27W 827/2700K 2550lm 35 °)

C0/C180 cd / 1000 lm

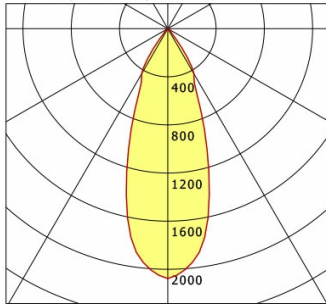

	C0	C90	C180	C270
0°	2077	2077	2077	2077
15°	1328	1328	1328	1328
30°	434	434	434	434
45°	20	20	20	20
60°	7	7	7	7
75°	4	4	4	4
90°	0	0	0	0
cd / 1000 lm				

Offset [m] Cone width [m] Illuminance [lx]

Offset [m]	Cone width [m]	Illuminance [lx]
3.0	1.97	588.5
6.0	3.94	147.1
9.0	5.91	65.4
12.0	7.88	36.8
15.0	9.86	23.5

η	LED
Efficiency	95 lm/W
Direct/Indirect	↓ 100% / ↑ 0%
System Power	27 W
UGR	X=4H, Y=8H
Reflection factors	70/50/20
UGR C0/C180	20.5
UGR C90/C270	20.5
CIE Flux Codes	97 99 100 100 100
Ra/CRI	>80

LTS

Accessories



ZB-OR DONGLE
Organic Response IR dongle kit



ZB-OR GATEWAY
Organic Response IoT Gateway Cascade Series



ZB-OR-R SENSOR
Organic Response sensor for recessed mounting



ZDAR 125.145-205
compensation ring for ceiling cut-outs from 145 to 205 mm