

CSALP 50.3040.35



Description

- recessed spotlight with conical light-head
- suitable for lighting of vertical surfaces
- luminaire rotates through 350° and light-head pivots out through 35°
- outstanding ease of maintenance
- no UV and thermal emissions
- thermal management with passive cooling (heat sink made from aluminium)
- specular aluminium reflector with precise symmetrical beam characteristic for high luminous efficiency and glare-free lighting
- front/recessed ring and light-head made from die-cast zinc
- clear safety glass
- tool-free ceiling mounting via quick-action clamping springs (automatic adjustment of the ceiling thickness)
- luminaire and ballast permanently connected via cable (length: 500 mm), ballast ready for mains connection
- ballast (LED converter) included (external placement)

Standard options



Special options



Colours	Article no.	EAN
black	643585	4043544497918
silver	643586	4043544497925
white	643587	4043544497932

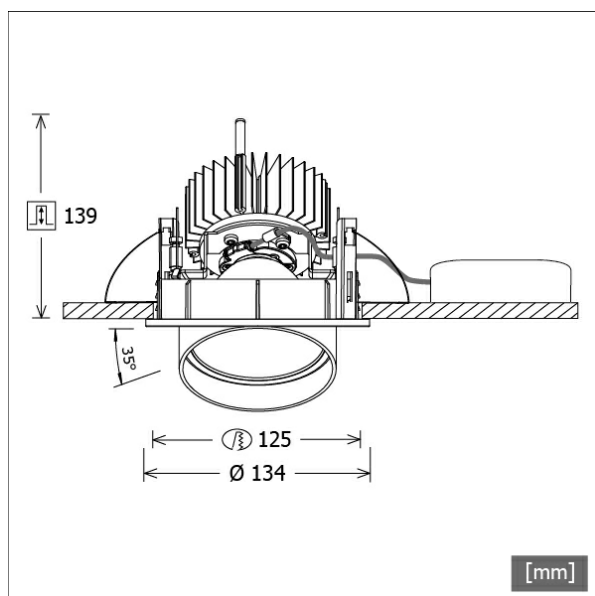

Lighting data / Norms

Lamps	LED Spot / CRI 80 / 4000 K
EPREL light sources	851282
Lifetime	L90 B50 50.000 h
	L80 B50 100.000 h
	L80 B20 50.000 h
System power	36.0 W
Luminaire luminous flux	3740 lm
System efficiency	103.88 lm/W
Module efficiency	162.17 lm/W
UGR class	≤22
Beam angle	35°
Supply voltage	220 - 240 V / 50 - 60 Hz
Protection class	II
Type of protection	IP20

Dimensions / Weights

Outer diameter	134 mm
Height	144 mm
Cut-out (Ø)	125 mm
Ceiling thickness	1.0 - 25.0 mm
Recessed depth	139 mm
Net weight	1.27 kg
Gross weight	1.34 kg



CSALP 50.3040.35

CSA 50 (1xLED 36W 840/4000K 3740lm 35 °)

C0/C180 cd / 1000 lm

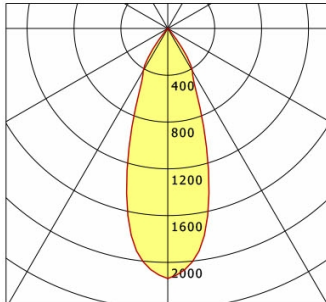

	C0	C90	C180	C270
0°	2138	2138	2138	2138
15°	1357	1357	1357	1357
30°	420	420	420	420
45°	13	13	13	13
60°	4	4	4	4
75°	3	3	3	3
90°	0	0	0	0
cd / 1000 lm				

Offset [m] Cone width [m] Illuminance [lx]

Offset [m]	Cone width [m]	Illuminance [lx]
3.0	1.95	888.5
6.0	3.90	222.1
9.0	5.86	98.7
12.0	7.81	55.5
15.0	9.76	35.5

η	LED
Efficiency	104 lm/W
Direct/Indirect	↓ 100% / ↑ 0%
System Power	36 W
UGR	X=4H, Y=8H
Reflection factors	70/50/20
UGR C0/C180	21.2
UGR C90/C270	21.2
CIE Flux Codes	98 99 100 100 100
Ra/CRI	>80

LTS

Accessories



ZDAR 125.145-205
compensation ring for ceiling cut-outs from 145 to 205 mm