

CSALP 50.3027.15



Description

- recessed spotlight with conical light-head
- suitable for lighting of vertical surfaces
- luminaire rotates through 350° and light-head pivots out through 35°
- outstanding ease of maintenance
- no UV and thermal emissions
- thermal management with passive cooling (heat sink made from aluminium)
- specular aluminium reflector with precise symmetrical beam characteristic for high luminous efficiency and glare-free lighting
- front/recessed ring and light-head made from die-cast zinc
- clear safety glass
- tool-free ceiling mounting via quick-action clamping springs (automatic adjustment of the ceiling thickness)
- luminaire and ballast permanently connected via cable (length: 500 mm), ballast ready for mains connection
- ballast (LED converter) included (external placement)

Standard options



Special options



Colours	Article no.	EAN
black	643525	4043544497314
silver	643526	4043544497321
white	643527	4043544497338

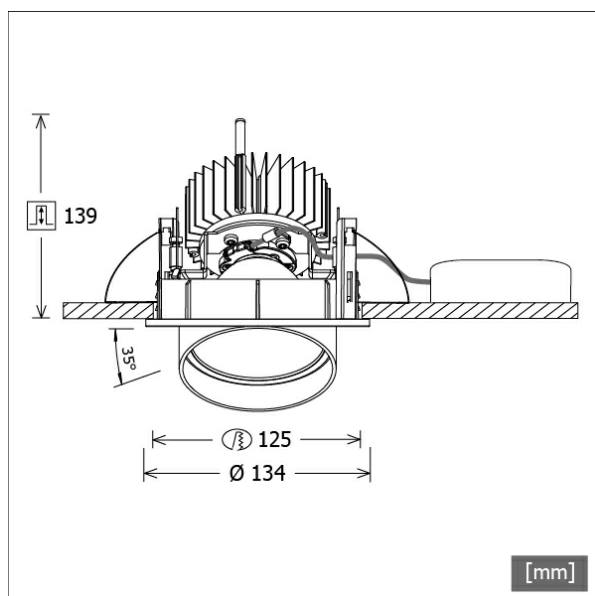

Lighting data / Norms

Lamps	LED Spot / CRI 80 / 2700 K
EPREL light sources	970823
Lifetime	L90 B50 50.000 h L80 B50 100.000 h L80 B20 50.000 h
System power	36.0 W
Luminaire luminous flux	3430 lm
System efficiency	95.27 lm/W
Module efficiency	128.62 lm/W
UGR class	≤22
Beam angle	15°
Supply voltage	220 - 240 V / 50 - 60 Hz
Protection class	II
Type of protection	IP20

Dimensions / Weights

Outer diameter	134 mm
Height	144 mm
Cut-out (Ø)	125 mm
Ceiling thickness	1.0 - 25.0 mm
Recessed depth	139 mm
Net weight	1.27 kg
Gross weight	1.34 kg



CSALP 50.3027.15

CSA 50 (1xLED 36W 827/2700K 3430lm 15 °)

C0/C180 cd / 1000 lm

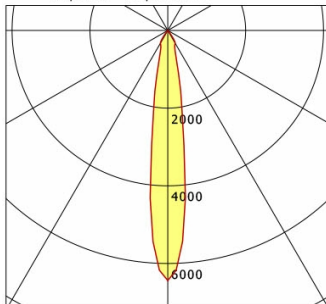

	C0	C90	C180	C270
0°	6438	6438	6438	6438
15°	967	967	967	967
30°	381	381	381	381
45°	4	4	4	4
60°	4	4	4	4
75°	2	2	2	2
90°	0	0	0	0
cd / 1000 lm				

Offset [m] Cone width [m] Illuminance [lx]

Offset [m]	Cone width [m]	Illuminance [lx]
3.0	0.80	2453.7
6.0	1.60	613.4
9.0	2.40	272.6
12.0	3.20	153.4
15.0	4.00	98.1

η	LED
Efficiency	96 lm/W
Direct/Indirect	↓ 100% / ↑ 0%
System Power	36 W
UGR	X=4H, Y=8H
Reflection factors	70/50/20
UGR C0/C180	19.7
UGR C90/C270	19.7
CIE Flux Codes	99 99 100 100 100
Ra/CRI	>80

LTS

Accessories



ZDAR 125.145-205
compensation ring for ceiling cut-outs from 145 to 205 mm