

VTFM-A 101.840



Description

- round surface-mounted downlight for diverse lighting tasks
- outstanding ease of maintenance
- no UV and thermal emissions
- innovative thermal management with passive cooling
- front ring and heat sink made from die-cast aluminium
- cylindrical housing made from aluminium
- microprism diffuser opal
- sheet steel mounting plate with snap-in fastener and safety rope for screw mounting
- 5-pole terminal block
- ballast (LED converter) integrated

Standard options



Lighting data / Norms

Lamps	LED Modul / CRI 80 / 4000 K
	L90 B50 50.000 h
Lifetime	L80 B50 100.000 h
	L80 B20 50.000 h
System power	20.4 W
Luminaire luminous flux	1840 lm
System efficiency	90.19 lm/W
UGR class	≤28
Supply voltage	220 - 240 V / 50 - 60 Hz
Protection class	I
Type of protection	IP20

Colours	Article no.	EAN
black	659024	4043544782168
silver	659025	4043544782175
white	659026	4043544782182

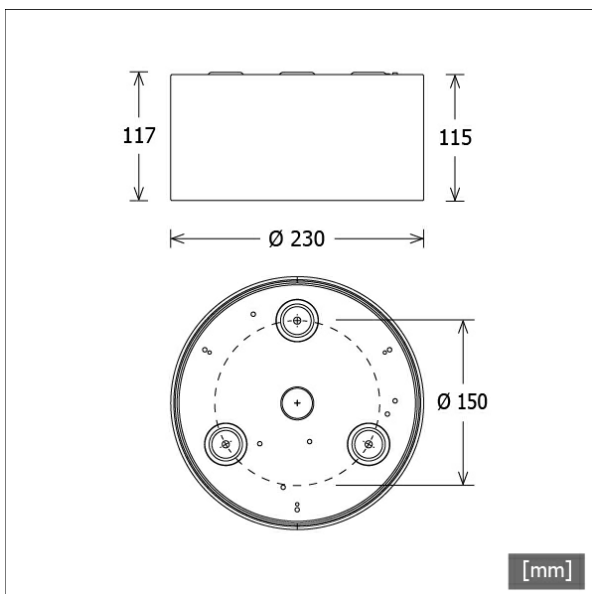

Dimensions / Weights

Outer diameter	230 mm
Height	117 mm
Net weight	1.47 kg
Gross weight	1.75 kg



VTFM-A 101.840

Vale-Tu Flat Medium | Surface-Mounted (1xLED 20W 840/4000K 1840lm)

C0/C180 cd / 1000 lm

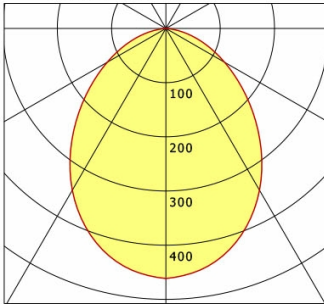

	C0	C90	C180	C270
0°	462	462	462	462
15°	429	429	429	429
30°	345	345	345	345
45°	230	230	230	230
60°	125	125	125	125
75°	45	45	45	45
90°	0	0	0	0
cd / 1000 lm				

Offset [m] Cone width [m] Illuminance [lx]

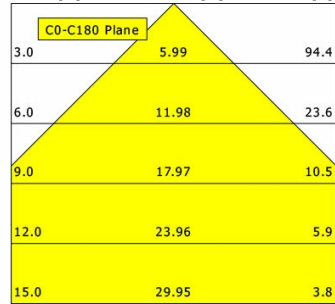

η	LED
Efficiency	92 lm/W
Direct/Indirect	↓ 100% / ↑ 0%
System Power	20 W
UGR	X=4H, Y=8H
Reflection factors	70/50/20
UGR C0/C180	26.6
UGR C90/C270	26.6
CIE Flux Codes	56 85 98 100 100
Ra/CRI	>80

LTS