

# FLIR 200.2030.50/DALI

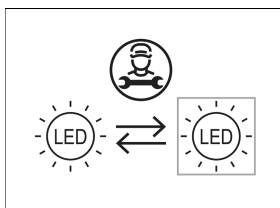

Coloris	Réf. article	EAN
noir	641756	4043544473028
argent	641757	4043544473035
blanc	641758	4043544473042

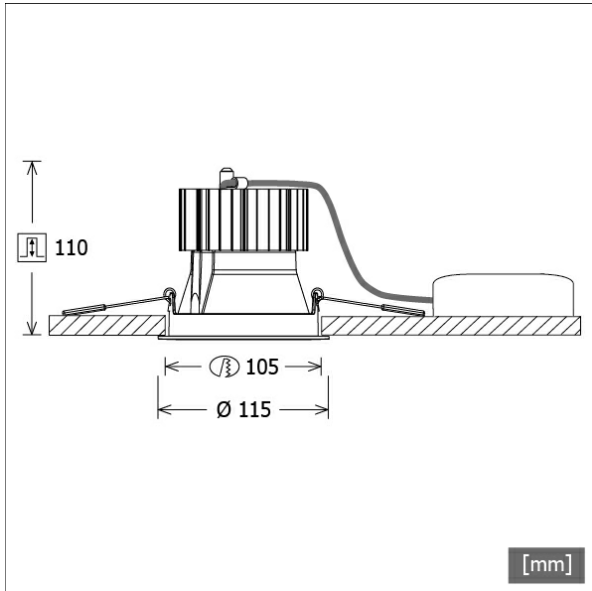

## Description

- projecteur à encastrement avec variantes optiques et pour une gamme étendue d'applications
- tête lampe orientable à 20°
- très simple à entretenir
- absence de radiations thermiques et UV
- gestion de la chaleur avec refroidissement passif (dissipateur thermique en aluminium)
- réflecteur-miroir en aluminium à hautes performances à faisceau symétrique précis pour un rendement lumineux maximal et le meilleur éclairage non éblouissant
- anneau d'encastrement/frontal en zinc moulé sous pression avec collerette à effet de lumière transparente (autres anneaux à effet de lumière/décoratifs et verres décoratifs disponibles en option)
- montage au plafond sans outils à l'aide de ressorts de serrage rapide (réglage automatique de l'épaisseur du plafond)
- Leuchte und Betriebsgerät über Kabel (Länge: 500 mm) fest verbunden, Betriebsgerät fertig für Netzanschluss
- ballast (convertisseur LED DALI, gradable) Inklus (positionnement extérieur)

## Options standard

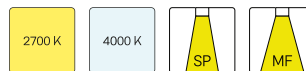

## Options spéciales



## Données d'éclairage / Normes

Lampes	LED Spot / CRI 80 / 3000 K
EPREL sources de lumière	848117
Durée de vie	L90 B50 50.000 h L80 B50 100.000 h L80 B20 50.000 h
Puissance du système	27.0 W
Flux lumineux des luminaires	max. 2880 lm
Rendement du système	106.66 lm/W
Rendement du module	156.64 lm/W
UGR classe	≤28
Zone de rayonnement	Wide Flood
Angle de rayonnement	51°
Tension d'alimentation	220 - 240 V / 50 - 60 Hz
Classe de protection	II
Type de protection	IP20

## Dimensions / Poids

Diamètre extérieur	115 mm
Hauteur	112 mm
Découpe (Ø)	105 mm
Épaisseur plafond	1.0 - 25.0 mm

Downlight à encastrement · Flixx 200 Round

FLIR 200.2030.50/DALI

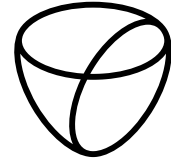

LTS  
LOVE TO SHINE

Profondeur d'encastrement	110 mm
Poids net	0.93 kg
Poids brut	1.01 kg

# FLIR 200.2030.50/DALI

## FLIR 200.2030.50/DALI

Flixx 200 Round (FLIRZ 200.05, 1xLED 27W 830/3000K 2880lm 51°)

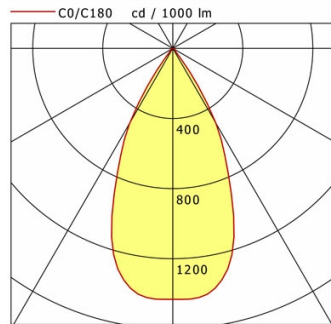

	C0	C90	C180	C270
0°	1431	1431	1431	1431
15°	1264	1264	1264	1264
30°	492	492	492	492
45°	17	17	17	17
60°	14	14	14	14
75°	6	6	6	6
90°	0	0	0	0
cd / 1000 lm				

Offset [m]	Cone width [m]	Illuminance [lx]
3.0	2.82	458.0
6.0	5.65	114.5
9.0	8.47	50.9
12.0	11.29	28.6
15.0	14.12	18.3

<b>η</b>	LED
Efficiency	107 lm/W
Direct/Indirect	↓ 100% / ↑ 0%
System Power	27 W
<b>UGR</b>	X=4H, Y=8H
Reflection factors	70/50/20
UGR C0/C180	21.4
UGR C90/C270	21.4
CIE Flux Codes	95 98 100 100 100
Ra/CRI	>80

LTS

## FLIR 200.2030.50/DALI

Flixx 200 Round (FLIRZ 200.24, 1xLED 27W 830/3000K 2710lm 51°)

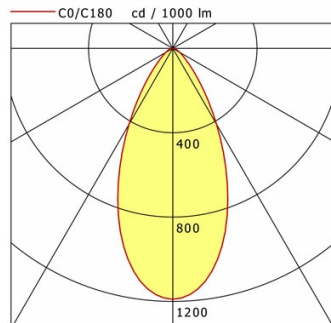

	C0	C90	C180	C270
0°	1190	1190	1190	1190
15°	936	936	936	936
30°	415	415	415	415
45°	116	116	116	116
60°	39	39	39	39
75°	16	16	16	16
90°	0	0	0	0
cd / 1000 lm				

Offset [m]	Cone width [m]	Illuminance [lx]
3.0	2.76	358.4
6.0	5.51	89.6
9.0	8.27	39.8
12.0	11.02	22.4
15.0	13.78	14.3

<b>η</b>	LED
Efficiency	100 lm/W
Direct/Indirect	↓ 100% / ↑ 0%
System Power	27 W
<b>UGR</b>	X=4H, Y=8H
Reflection factors	70/50/20
UGR C0/C180	26.4
UGR C90/C270	26.4
CIE Flux Codes	83 95 99 100 100
Ra/CRI	>80

LTS

## FLIR 200.2030.50/DALI

Flixx 200 Round (FLIRZ 200.25, 1xLED 27W 830/3000K 2800lm 51°)

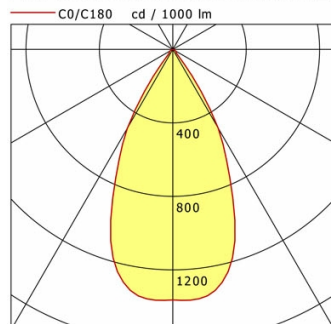

	C0	C90	C180	C270
0°	1364	1364	1364	1364
15°	1216	1216	1216	1216
30°	494	494	494	494
45°	27	27	27	27
60°	17	17	17	17
75°	6	6	6	6
90°	0	0	0	0
cd / 1000 lm				

Offset [m]	Cone width [m]	Illuminance [lx]
3.0	2.89	424.3
6.0	5.77	106.1
9.0	8.66	47.1
12.0	11.54	26.5
15.0	14.43	17.0

<b>η</b>	LED
Efficiency	104 lm/W
Direct/Indirect	↓ 100% / ↑ 0%
System Power	27 W
<b>UGR</b>	X=4H, Y=8H
Reflection factors	70/50/20
UGR C0/C180	21.6
UGR C90/C270	21.6
CIE Flux Codes	94 98 100 100 100
Ra/CRI	>80

LTS

# FLIR 200.2030.50/DALI

## Accessoires



**FLIRZ 200.01**  
Anneau décoratif noir



**FLIRZ 200.02**  
Anneau décoratif argent



**FLIRZ 200.03**  
Anneau décoratif blanc



**FLIRZ 200.04**  
Anneau à effet lumière opale



**FLIRZ 200.05**  
Anneau à effet lumière transparent



**FLIRZ 200.06**  
Anneau à effet lumière rouge opaque



**FLIRZ 200.07**  
Anneau à effet lumière jaune opaque



**FLIRZ 200.08**  
Boîtier à effet lumière bleu opaque



**FLIRZ 200.16**  
Anneau à effet lumière rouge translucide



**FLIRZ 200.17**  
Anneau à effet lumière jaune translucide



**FLIRZ 200.18**  
Boîtier à effet lumière bleu translucide

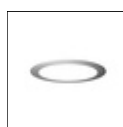

**FLIRZ 200.24**  
Verre de décoration opale



**FLIRZ 200.25**  
Verre de décoration transparent



**ZB-OR DONGLE**  
Organic Response kit dongle IR



**ZB-OR GATEWAY**  
Organic Response passerelle IoT série Cascade



**ZB-OR-R SENSOR**  
capteur Organic Response pour montage encastré