

# LK-L 045.10840.0985.1/DALI



## Description

- module lumière en tôle d'acier avec modules LED intégrés
- absence de radiations thermiques et UV
- possibilité de réaliser des bandes de toutes les longueurs
- kit de câbles inclus (à 5 pôles)
- diffuseur en PMMA bombé pour une diffusion homogène de la lumière
- encastrement dans le profil sans outils
- borne à 5 pôles, préassemblée, pour câblage passant à 5 pôles
- ballast (convertisseur LED DALI, gradable) intégré

## Observations

La dilatation thermique linéaire du profil en aluminium à dT = 10 Kelvins est de 0,3 mm au mètre.

## Options standard



## Options spéciales



Coloris	Réf. article	EAN
	669404	4043544810809



## Données d'éclairage / Normes

Lampes	LED linéar / CRI 80 / 4000 K
Durée de vie	L90 B50 50.000 h L80 B50 100.000 h L80 B20 50.000 h
Puissance du système	14.3 W
Flux lumineux des luminaires	max. 2140 lm
Rendement du système	149.65 lm/W
Rendement du module	205.00 lm/W
UGR classe	≤28
Tension d'alimentation	220 - 240 V / 50 - 60 Hz
Classe de protection	I

## Dimensions / Poids

Longueur	985 mm
Largeur	43 mm
Hauteur	44 mm
Poids net	0.84 kg
Poids brut	0.94 kg



# LK-L 045.10840.0985.1/DALI

## LK-L 045.10840.0985.1/DALI

Lichtkanal 045 | Light-Insert (AOB, 1xLED 14W 840/4000K 2140lm)

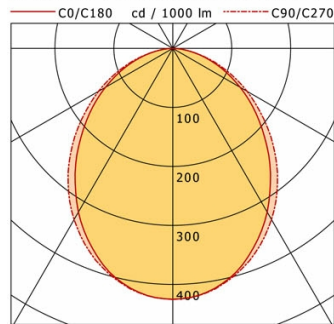

	C0	C90	C180	C270
0°	425	425	425	425
15°	397	400	397	400
30°	320	335	320	335
45°	223	244	223	244
60°	132	146	132	146
75°	54	57	54	57
90°	1	0	1	0

cd / 1000 lm

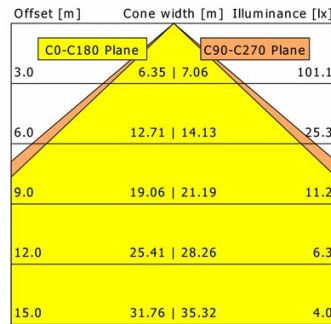

<b>η</b>	LED
Efficiency	153 lm/W
Direct/Indirect	↓ 100% / ↑ 0%
System Power	14 W
<b>UGR</b>	X=4H, Y=8H
Reflection factors	70/50/20
UGR C0/C180	25.2
UGR C90/C270	25.3
CIE Flux Codes	52 82 96 100 100
Ra/CRI	>80

LTS

## LK-L 045.10840.0985.1/DALI

Lichtkanal 045 | Light-Insert (AOV-001/003/005.1, 1xLED 14W 840/4000K 2020lm)

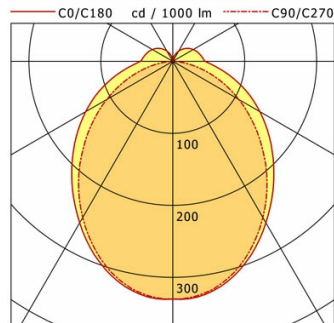

	C0	C90	C180	C270
0°	330	330	330	330
30°	259	251	259	251
60°	140	106	140	106
90°	45	1	45	1
120°	33	0	33	0
150°	16	1	16	1
180°	1	1	1	1

cd / 1000 lm

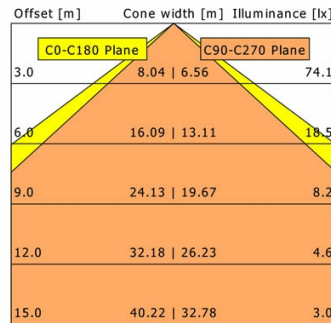

<b>η</b>	LED
Efficiency	144 lm/W
Direct/Indirect	↓ 89% / ↑ 11%
System Power	14 W
<b>UGR</b>	X=4H, Y=8H
Reflection factors	70/50/20
UGR C0/C180	26.9
UGR C90/C270	23.6
CIE Flux Codes	47 76 92 89 100
Ra/CRI	>80

LTS

## LK-L 045.10840.0985.1/DALI

Lichtkanal 045 | Light-Insert (APB, 1xLED 14W 840/4000K 2070lm)

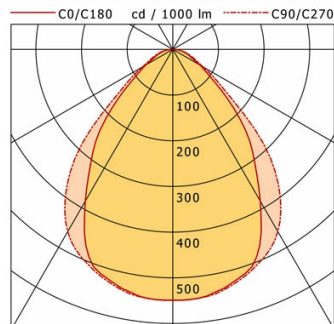

	C0	C90	C180	C270
0°	549	549	549	549
15°	525	529	525	529
30°	384	461	384	461
45°	199	267	199	267
60°	69	76	69	76
75°	27	32	27	32
90°	0	0	0	0

cd / 1000 lm

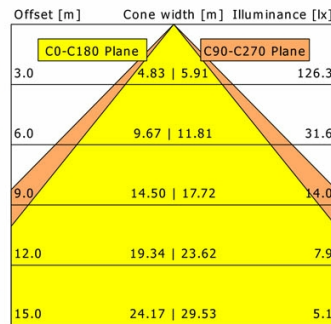

<b>η</b>	LED
Efficiency	148 lm/W
Direct/Indirect	↓ 100% / ↑ 0%
System Power	14 W
<b>UGR</b>	X=4H, Y=8H
Reflection factors	70/50/20
UGR C0/C180	21.5
UGR C90/C270	22.1
CIE Flux Codes	67 91 98 100 100
Ra/CRI	>80

LTS

## LK-L 045.10840.0985.1/DALI

Lichtkanal 045 | Light-Insert (AOV-002/005.2, 1xLED 14W 840/4000K 2020lm)

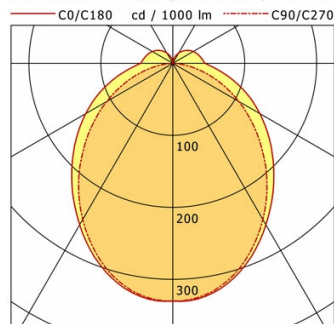

	C0	C90	C180	C270
0°	330	330	330	330
30°	259	251	259	251
60°	140	106	140	106
90°	45	1	45	1
120°	33	0	33	0
150°	16	1	16	1
180°	1	1	1	1

cd / 1000 lm

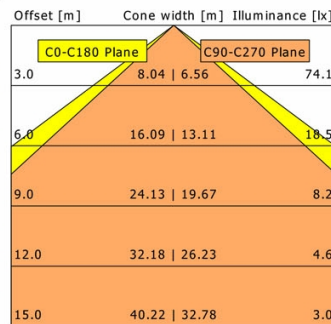

<b>η</b>	LED
Efficiency	144 lm/W
Direct/Indirect	↓ 89% / ↑ 11%
System Power	14 W
<b>UGR</b>	X=4H, Y=8H
Reflection factors	70/50/20
UGR C0/C180	26.9
UGR C90/C270	23.6
CIE Flux Codes	47 76 92 89 100
Ra/CRI	>80

LTS