

LK-L 045.10830.1685.1/DALI



Description

- module lumière en tôle d'acier avec modules LED intégrés
- absence de radiations thermiques et UV
- possibilité de réaliser des bandes de toutes les longueurs
- kit de câbles inclus (à 5 pôles)
- diffuseur en PMMA bombé pour une diffusion homogène de la lumière
- encastrement dans le profil sans outils
- borne à 5 pôles, préassemblée, pour câblage passant à 5 pôles
- ballast (convertisseur LED DALI, gradable) intégré

Observations

La dilatation thermique linéaire du profil en aluminium à dT = 10 Kelvins est de 0,3 mm au mètre.

Options standard



Options spéciales



| Coloris | Réf. article | EAN |
|---------|--------------|---------------|
| | 669409 | 4043544810854 |

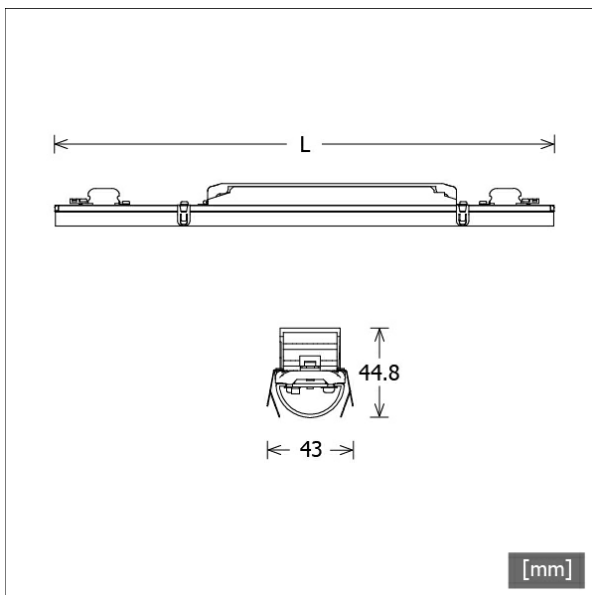

Données d'éclairage / Normes

| | |
|------------------------------|---|
| Lampes | LED linéar / CRI 80 / 3000 K |
| Durée de vie | L90 B50 50.000 h L80 B50 100.000 h L80 B20 50.000 h |
| Puissance du système | 24.5 W |
| Flux lumineux des luminaires | max. 3460 lm |
| Rendement du système | 133.06 lm/W |
| Rendement du module | 193.00 lm/W |
| UGR classe | ≤28 |
| Tension d'alimentation | 220 - 240 V / 50 - 60 Hz |
| Classe de protection | I |

Dimensions / Poids

| | |
|------------|---------|
| Longueur | 1685 mm |
| Largeur | 43 mm |
| Hauteur | 44 mm |
| Poids net | 1.57 kg |
| Poids brut | 1.82 kg |

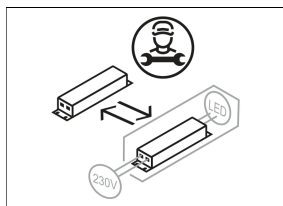
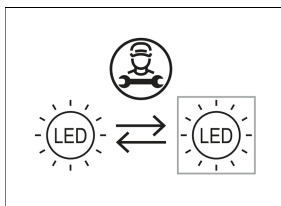

LK-L 045.10830.1685.1/DALI

LK-L 045.10830.1685.1/DALI

Lichtkanal 045 | Light-Insert (AOV-001/003/005.1, 1xLED 25W 830/3000K 3260lm)

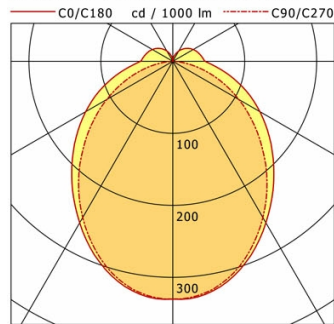

| | C0 | C90 | C180 | C270 |
|------|-----|-----|------|------|
| 0° | 330 | 330 | 330 | 330 |
| 30° | 259 | 251 | 259 | 251 |
| 60° | 140 | 106 | 140 | 106 |
| 90° | 45 | 1 | 45 | 1 |
| 120° | 33 | 0 | 33 | 0 |
| 150° | 16 | 1 | 16 | 1 |
| 180° | 1 | 1 | 1 | 1 |

cd / 1000 lm

| Offset [m] | Cone width [m] | | Illuminance [lx] |
|------------|----------------|-------|------------------|
| 3.0 | 8.04 | 6.56 | 119.6 |
| 6.0 | 16.09 | 13.11 | 29.9 |
| 9.0 | 24.13 | 19.67 | 13.3 |
| 12.0 | 32.18 | 26.23 | 7.5 |
| 15.0 | 40.22 | 32.78 | 4.8 |

| | |
|--------------------|-----------------|
| η | LED |
| Efficiency | 130 lm/W |
| Direct/Indirect | ↓ 89% / ↑ 11% |
| System Power | 25 W |
| UGR | X=4H, Y=8H |
| Reflection factors | 70/50/20 |
| UGR C0/C180 | 26.7 |
| UGR C90/C270 | 23.4 |
| CIE Flux Codes | 47 76 92 89 100 |
| Ra/CRI | >80 |

LTS

LK-L 045.10830.1685.1/DALI

Lichtkanal 045 | Light-Insert (AOV-002/005.2, 1xLED 25W 830/3000K 3260lm)

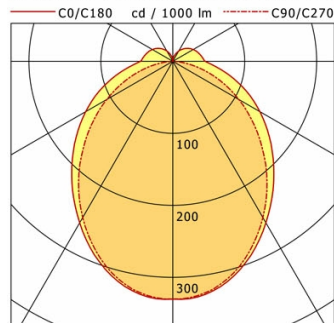

| | C0 | C90 | C180 | C270 |
|------|-----|-----|------|------|
| 0° | 330 | 330 | 330 | 330 |
| 30° | 259 | 251 | 259 | 251 |
| 60° | 140 | 106 | 140 | 106 |
| 90° | 45 | 1 | 45 | 1 |
| 120° | 33 | 0 | 33 | 0 |
| 150° | 16 | 1 | 16 | 1 |
| 180° | 1 | 1 | 1 | 1 |

cd / 1000 lm

| Offset [m] | Cone width [m] | | Illuminance [lx] |
|------------|----------------|-------|------------------|
| 3.0 | 8.04 | 6.56 | 119.6 |
| 6.0 | 16.09 | 13.11 | 29.9 |
| 9.0 | 24.13 | 19.67 | 13.3 |
| 12.0 | 32.18 | 26.23 | 7.5 |
| 15.0 | 40.22 | 32.78 | 4.8 |

| | |
|--------------------|-----------------|
| η | LED |
| Efficiency | 130 lm/W |
| Direct/Indirect | ↓ 89% / ↑ 11% |
| System Power | 25 W |
| UGR | X=4H, Y=8H |
| Reflection factors | 70/50/20 |
| UGR C0/C180 | 26.7 |
| UGR C90/C270 | 23.4 |
| CIE Flux Codes | 47 76 92 89 100 |
| Ra/CRI | >80 |

LTS

LK-L 045.10830.1685.1/DALI

Lichtkanal 045 | Light-Insert (APB, 1xLED 25W 830/3000K 3350lm)

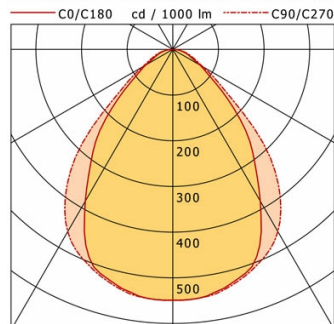

| | C0 | C90 | C180 | C270 |
|-----|-----|-----|------|------|
| 0° | 549 | 549 | 549 | 549 |
| 15° | 525 | 529 | 525 | 529 |
| 30° | 384 | 461 | 384 | 461 |
| 45° | 199 | 267 | 199 | 267 |
| 60° | 69 | 76 | 69 | 76 |
| 75° | 27 | 32 | 27 | 32 |
| 90° | 0 | 0 | 0 | 0 |

cd / 1000 lm

| Offset [m] | Cone width [m] | | Illuminance [lx] |
|------------|----------------|-------|------------------|
| 3.0 | 4.83 | 5.91 | 204.4 |
| 6.0 | 9.67 | 11.81 | 51.1 |
| 9.0 | 14.50 | 17.72 | 22.7 |
| 12.0 | 19.34 | 23.62 | 12.8 |
| 15.0 | 24.17 | 29.53 | 8.2 |

| | |
|--------------------|------------------|
| η | LED |
| Efficiency | 134 lm/W |
| Direct/Indirect | ↓ 100% / ↑ 0% |
| System Power | 25 W |
| UGR | X=4H, Y=8H |
| Reflection factors | 70/50/20 |
| UGR C0/C180 | 21.3 |
| UGR C90/C270 | 21.9 |
| CIE Flux Codes | 67 91 98 100 100 |
| Ra/CRI | >80 |

LTS

LK-L 045.10830.1685.1/DALI

Lichtkanal 045 | Light-Insert (AOB, 1xLED 25W 830/3000K 3460lm)

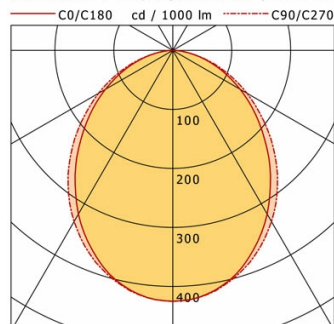

| | C0 | C90 | C180 | C270 |
|-----|-----|-----|------|------|
| 0° | 425 | 425 | 425 | 425 |
| 15° | 397 | 400 | 397 | 400 |
| 30° | 320 | 335 | 320 | 335 |
| 45° | 223 | 244 | 223 | 244 |
| 60° | 132 | 146 | 132 | 146 |
| 75° | 54 | 57 | 54 | 57 |
| 90° | 1 | 0 | 1 | 0 |

cd / 1000 lm

| Offset [m] | Cone width [m] | | Illuminance [lx] |
|------------|----------------|-------|------------------|
| 3.0 | 6.35 | 7.06 | 163.5 |
| 6.0 | 12.71 | 14.13 | 40.9 |
| 9.0 | 19.06 | 21.19 | 18.2 |
| 12.0 | 25.41 | 28.26 | 10.2 |
| 15.0 | 31.76 | 35.32 | 6.5 |

| | |
|--------------------|------------------|
| η | LED |
| Efficiency | 138 lm/W |
| Direct/Indirect | ↓ 100% / ↑ 0% |
| System Power | 25 W |
| UGR | X=4H, Y=8H |
| Reflection factors | 70/50/20 |
| UGR C0/C180 | 25.0 |
| UGR C90/C270 | 25.1 |
| CIE Flux Codes | 52 82 96 100 100 |
| Ra/CRI | >80 |

LTS