

LK-L 045.11830.0985.1/DALI



Description

- module lumière en tôle d'acier avec modules LED intégrés
- absence de radiations thermiques et UV
- possibilité de réaliser des bandes de toutes les longueurs
- kit de câbles inclus (à 5 pôles)
- diffuseur en PMMA bombé pour une diffusion homogène de la lumière
- encastrement dans le profil sans outils
- borne à 5 pôles, préassemblée, pour câblage passant à 5 pôles
- ballast (convertisseur LED DALI, gradable) intégré

Observations

La dilatation thermique linéaire du profil en aluminium à dT = 10 Kelvins est de 0,3 mm au mètre.

Options standard



Options spéciales



Coloris	Réf. article	EAN
	669415	4043544810915



Données d'éclairage / Normes

Lampes	LED linéar / CRI 80 / 3000 K
Durée de vie	L90 B50 50.000 h L80 B50 100.000 h L80 B20 50.000 h
Puissance du système	22.1 W
Flux lumineux des luminaires	max. 3100 lm
Rendement du système	140.27 lm/W
Rendement du module	193.00 lm/W
UGR classe	≤28
Tension d'alimentation	220 - 240 V / 50 - 60 Hz
Classe de protection	I

Dimensions / Poids

Longueur	985 mm
Largeur	43 mm
Hauteur	44 mm
Poids net	0.84 kg
Poids brut	0.94 kg



LK-L 045.11830.0985.1/DALI

LK-L 045.11830.0985.1/DALI

Lichtkanal 045 | Light-Insert (AOB, 1xLED 22W 830/3000K 3100lm)

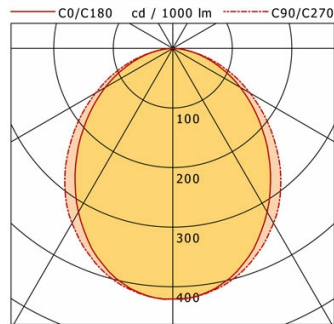

	C0	C90	C180	C270
0°	421	421	421	421
15°	394	399	394	399
30°	317	339	317	339
45°	222	250	222	250
60°	131	150	131	150
75°	54	60	54	60
90°	1	0	1	0
cd / 1000 lm				

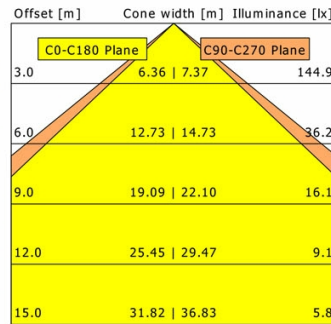

η	LED
Efficiency	141 lm/W
Direct/Indirect	↓ 100% / ↑ 0%
System Power	22 W
UGR	X=4H, Y=8H
Reflection factors	70/50/20
UGR C0/C180	26.5
UGR C90/C270	26.7
CIE Flux Codes	52 82 96 100 100
Ra/CRI	>80

LTS

LK-L 045.11830.0985.1/DALI

Lichtkanal 045 | Light-Insert (AOV-001/003/005.1, 1xLED 22W 830/3000K 2920lm)

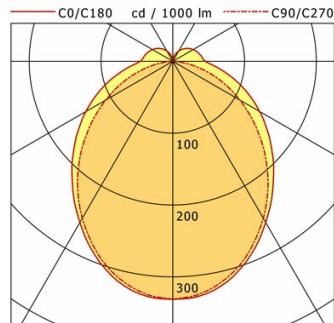

	C0	C90	C180	C270
0°	331	331	331	331
30°	259	252	259	252
60°	140	109	140	109
90°	45	1	45	1
120°	33	0	33	0
150°	16	0	16	0
180°	1	1	1	1
cd / 1000 lm				

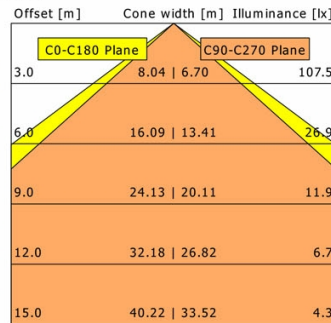

η	LED
Efficiency	133 lm/W
Direct/Indirect	↓ 89% / ↑ 11%
System Power	22 W
UGR	X=4H, Y=8H
Reflection factors	70/50/20
UGR C0/C180	28.2
UGR C90/C270	24.9
CIE Flux Codes	47 76 92 89 100
Ra/CRI	>80

LTS

LK-L 045.11830.0985.1/DALI

Lichtkanal 045 | Light-Insert (APB, 1xLED 22W 830/3000K 2970lm)

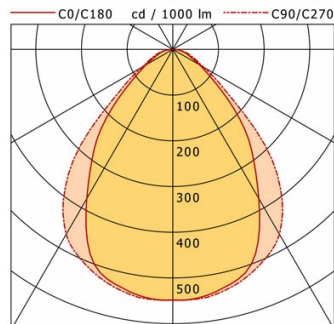

	C0	C90	C180	C270
0°	548	548	548	548
15°	526	533	526	533
30°	377	468	377	468
45°	198	271	198	271
60°	68	78	68	78
75°	27	33	27	33
90°	1	0	1	0
cd / 1000 lm				

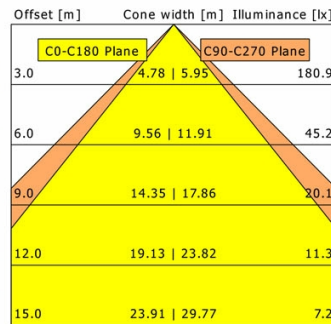

η	LED
Efficiency	135 lm/W
Direct/Indirect	↓ 100% / ↑ 0%
System Power	22 W
UGR	X=4H, Y=8H
Reflection factors	70/50/20
UGR C0/C180	22.7
UGR C90/C270	23.4
CIE Flux Codes	67 91 98 100 100
Ra/CRI	>80

LTS

LK-L 045.11830.0985.1/DALI

Lichtkanal 045 | Light-Insert (AOV-002/005.2, 1xLED 22W 830/3000K 2920lm)

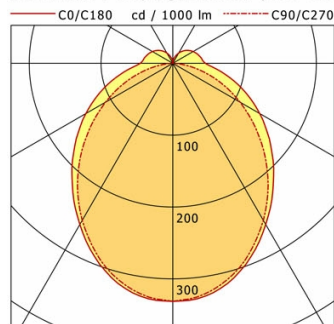

	C0	C90	C180	C270
0°	331	331	331	331
30°	259	252	259	252
60°	140	109	140	109
90°	45	1	45	1
120°	33	0	33	0
150°	16	0	16	0
180°	1	1	1	1
cd / 1000 lm				

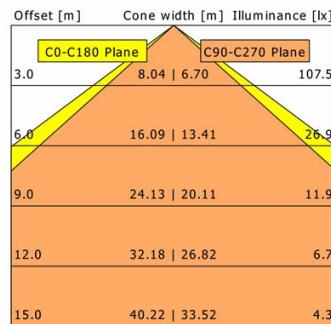

η	LED
Efficiency	133 lm/W
Direct/Indirect	↓ 89% / ↑ 11%
System Power	22 W
UGR	X=4H, Y=8H
Reflection factors	70/50/20
UGR C0/C180	28.2
UGR C90/C270	24.9
CIE Flux Codes	47 76 92 89 100
Ra/CRI	>80

LTS