

LK-L 045.11840.0705.1/DALI



Descrizione

- inserto modulo in lamiera d'acciaio con moduli LED integrati
- assenza di radiazioni termiche e UV
- si possono realizzare strisce di qualsiasi lunghezza
- set di cavi incluso (a 5 poli)
- diffusore curvo in PMMA per una diffusione omogenea della luce
- innesto nel profilo senza attrezzi
- morsetto a 5 poli, preassemblato per cablaggio passante a 5 poli
- alimentatore (convertitore LED DALI, dimmerabile) integrato

Note

La dilatazione termica lineare del profilo di alluminio a dT = 10 Kelvin è di 0,3 mm al metro.

Opzioni standard



Opzioni speciali



Colori	Articolo n.	EAN
	669412	4043544810885

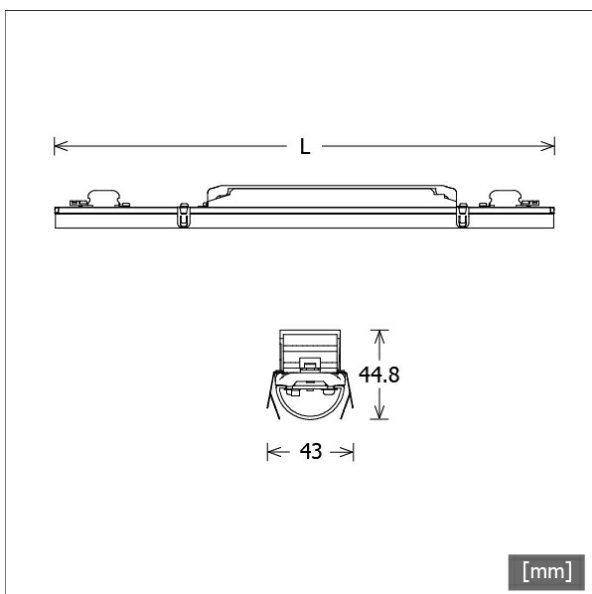

Dati illuminotecnici / Norme

Lampade	LED linear / CRI 80 / 4000 K
Durata	L90 B50 50.000 h L80 B50 100.000 h L80 B20 50.000 h
Prestazioni sistema	15.8 W
Flusso luminoso apparecchio	max. 2340 lm
Efficienza sistema	148.10 lm/W
Efficienza del modulo	205.00 lm/W
UGR classe	≤28
Tensione di alimentazione	220 - 240 V / 50 - 60 Hz
Classe di protezione	I

Dimensioni / pesi

Lunghezza	705 mm
Larghezza	43 mm
Altezza	44 mm
Peso netto	0.72 kg
Peso lordo	0.92 kg



LK-L 045.11840.0705.1/DALI

LK-L 045.11840.0705.1/DALI

Lichtkanal 045 | Light-Insert (AOB, 1xLED 16W 840/4000K 2340lm)

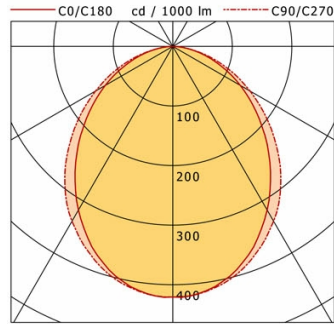

	C0	C90	C180	C270
0°	421	421	421	421
15°	394	399	394	399
30°	317	339	317	339
45°	222	250	222	250
60°	131	150	131	150
75°	54	60	54	60
90°	1	0	1	0
cd / 1000 lm				

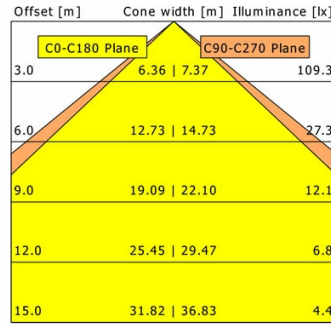

η	LED
Efficiency	146 lm/W
Direct/Indirect	↓ 100% / ↑ 0%
System Power	16 W
UGR	X=4H, Y=8H
Reflection factors	70/50/20
UGR C0/C180	26.7
UGR C90/C270	26.9
CIE Flux Codes	52 82 96 100 100
Ra/CRI	>80

LTS

LK-L 045.11840.0705.1/DALI

Lichtkanal 045 | Light-Insert (AOV-001/003/005.1, 1xLED 16W 840/4000K 2220lm)

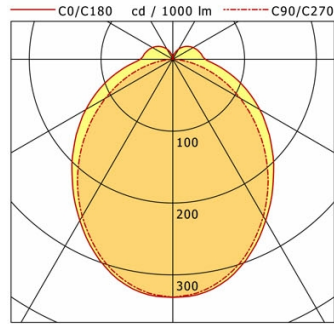

	C0	C90	C180	C270
0°	331	331	331	331
30°	259	252	259	252
60°	140	109	140	109
90°	45	1	45	1
120°	33	0	33	0
150°	16	0	16	0
180°	1	1	1	1
cd / 1000 lm				

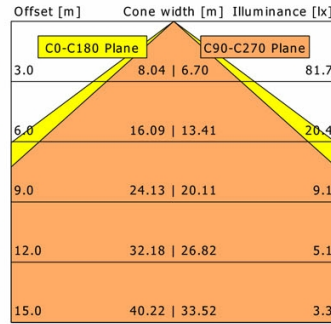

η	LED
Efficiency	139 lm/W
Direct/Indirect	↓ 89% / ↑ 11%
System Power	16 W
UGR	X=4H, Y=8H
Reflection factors	70/50/20
UGR C0/C180	28.4
UGR C90/C270	25.1
CIE Flux Codes	47 76 92 89 100
Ra/CRI	>80

LTS

LK-L 045.11840.0705.1/DALI

Lichtkanal 045 | Light-Insert (APB, 1xLED 16W 840/4000K 2250lm)

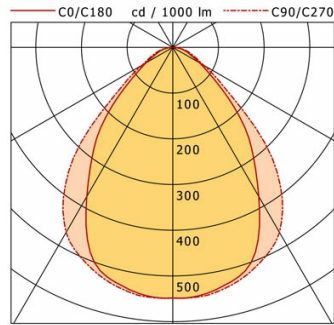

	C0	C90	C180	C270
0°	548	548	548	548
15°	526	533	526	533
30°	377	468	377	468
45°	198	271	198	271
60°	68	78	68	78
75°	27	33	27	33
90°	1	0	1	0
cd / 1000 lm				

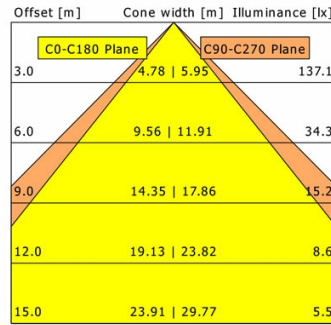

η	LED
Efficiency	141 lm/W
Direct/Indirect	↓ 100% / ↑ 0%
System Power	16 W
UGR	X=4H, Y=8H
Reflection factors	70/50/20
UGR C0/C180	22.9
UGR C90/C270	23.6
CIE Flux Codes	67 91 98 100 100
Ra/CRI	>80

LTS

LK-L 045.11840.0705.1/DALI

Lichtkanal 045 | Light-Insert (AOV-002/005.2, 1xLED 16W 840/4000K 2220lm)

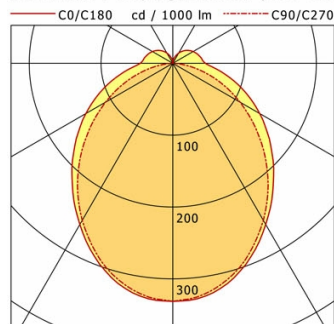

	C0	C90	C180	C270
0°	331	331	331	331
30°	259	252	259	252
60°	140	109	140	109
90°	45	1	45	1
120°	33	0	33	0
150°	16	0	16	0
180°	1	1	1	1
cd / 1000 lm				

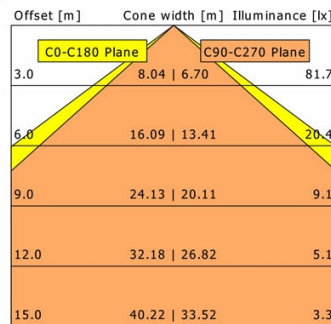

η	LED
Efficiency	139 lm/W
Direct/Indirect	↓ 89% / ↑ 11%
System Power	16 W
UGR	X=4H, Y=8H
Reflection factors	70/50/20
UGR C0/C180	28.4
UGR C90/C270	25.1
CIE Flux Codes	47 76 92 89 100
Ra/CRI	>80

LTS