

SCEKLP 6.2030.15/DALI

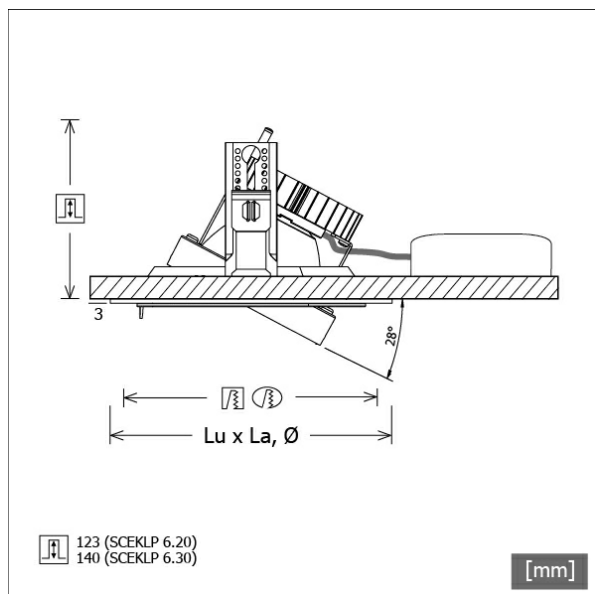

Colori	Articolo n.	EAN
nero	645139	4043544517029
argento	645140	4043544517036
bianco	645141	4043544517043



Descrizione

- sistema di faretti da incasso flessibili costituito da cornici da incasso, teste lampada e alimentatori (cornici da incasso da ordinare separatamente)
- teste lampada direzionabili a 28° su giunti cardanici
- elevata facilità di manutenzione
- assenza di radiazioni termiche e UV
- gestione termica con raffreddamento passivo (termodispersore in alluminio)
- sospensioni cardaniche in pressofusione di zinco e policarbonato
- riflettore a specchio in alluminio con curva fotometrica simmetrica precisa per un'alta resa luminosa e il controllo ottimale dell'abbagliamento
- vetro di protezione trasparente
- innesto della testa lampada nella cornice da incasso senza attrezzi
- collegamento all'alimentatore tramite cavo lampada con connettore Mini-Clamp
- alimentatore (convertitore LED DALI, dimmerabile) incluso (posizionamento esterno)

Opzioni standard



Opzioni speciali



Dati illuminotecnici / Norme

Lampade	LED Spot / CRI 80 / 3000 K
EPREL fonti luminose	848117
Durata	L90 B50 50.000 h
	L80 B50 100.000 h
	L80 B20 50.000 h
Prestazioni sistema	25.8 W
Flusso luminoso apparecchio	2710 lm
Efficienza sistema	105.03 lm/W
Efficienza del modulo	156.64 lm/W
UGR classe	≤19
Zona di fascio luminoso	Spot
Angolo del fascio luminoso	14°
Tensione di alimentazione	220 - 240 V / 50 - 60 Hz
Classe di protezione	III
Tipo di protezione	IP20

Dimensioni / pesi

Altezza	126 mm
Profondità di incasso	123 mm
Diametro testa lampada	154 mm
Peso netto	0.86 kg
Peso lordo	0.90 kg

SCEKLP 6.2030.15/DALI

SCEKLP 6.2030.15/DALI

Scene 6 System | Light-Head (1xLED 26W 830/3000K 2710lm)

C0/C180 cd / 1000 lm

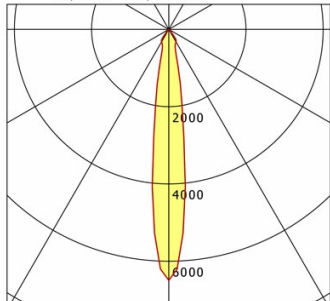

	C0	C90	C180	C270
0°	6495	6495	6495	6495
15°	830	830	830	830
30°	374	374	374	374
45°	20	20	20	20
60°	2	2	2	2
75°	0	0	0	0
90°	0	0	0	0

cd / 1000 lm

Offset [m] Cone width [m] Illuminance [lx]

Offset [m]	Cone width [m]	Illuminance [lx]
3.0	0.76	1955.6
6.0	1.52	488.9
9.0	2.28	217.3
12.0	3.04	122.2
15.0	3.80	78.2

η	LED
Efficiency	105 lm/W
Direct/Indirect	↓ 100% / ↑ 0%
System Power	26 W
UGR	X=4H, Y=8H
Reflection factors	70/50/20
UGR C0/C180	19.1
UGR C90/C270	19.1
CIE Flux Codes	98 100 100 100 100
Ra/CRI	>80

LTS

Accessori



SCER 6.100
Cornice da incasso 1 punto luce



SCER 6.111
Cornice da incasso (rotonda) 1 punto luce

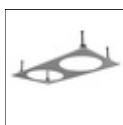

SCER 6.200
Cornice da incasso 2 punti luce

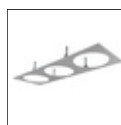

SCER 6.300
Cornice da incasso 3 punti luce



SCER 6.310
Cornice da incasso (rotonda) 3 punti luce

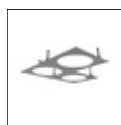

SCER 6.330
Cornice angolare a incasso a 3 punti luce

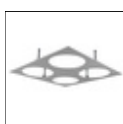

SCER 6.400
Cornice da incasso 4 punti luce



ZB-OR DONGLE
Organic Response Kit dongle IR



ZB-OR GATEWAY
Organic Response serie a cascata gateway IoT



ZB-OR-R SENSOR
sensore Organic Response per montaggio a incasso