

LK-L 045.10840.0705.1/DALI



Descrizione

- inserto modulo in lamiera d'acciaio con moduli LED integrati
- assenza di radiazioni termiche e UV
- si possono realizzare strisce di qualsiasi lunghezza
- set di cavi incluso (a 5 poli)
- diffusore curvo in PMMA per una diffusione omogenea della luce
- innesto nel profilo senza attrezzi
- morsetto a 5 poli, preassemblato per cablaggio passante a 5 poli
- alimentatore (convertitore LED DALI, dimmerabile) integrato

Note

La dilatazione termica lineare del profilo di alluminio a dT = 10 Kelvin è di 0,3 mm al metro.

Opzioni standard



Opzioni speciali



Colori	Articolo n.	EAN
	669400	4043544810762



Dati illuminotecnici / Norme

Lampade	LED linear / CRI 80 / 4000 K
Durata	L90 B50 50.000 h L80 B50 100.000 h L80 B20 50.000 h
Prestazioni sistema	10.2 W
Flusso luminoso apparecchio	max. 1530 lm
Efficienza sistema	150.00 lm/W
Efficienza del modulo	205.00 lm/W
UGR classe	≤28
Tensione di alimentazione	220 - 240 V / 50 - 60 Hz
Classe di protezione	I

Dimensioni / pesi

Lunghezza	705 mm
Larghezza	43 mm
Altezza	44 mm
Peso netto	0.72 kg
Peso lordo	0.92 kg



LK-L 045.10840.0705.1/DALI

LK-L 045.10830.0705.1/DALI

Lichtkanal 045 | Light-Insert (AOB, 1xLED 10W 830/3000K 1440lm)

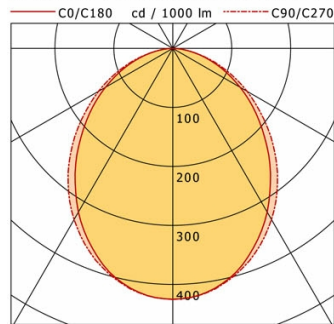

	C0	C90	C180	C270
0°	425	425	425	425
15°	397	400	397	400
30°	320	335	320	335
45°	223	244	223	244
60°	132	146	132	146
75°	54	57	54	57
90°	1	0	1	0
cd / 1000 lm				

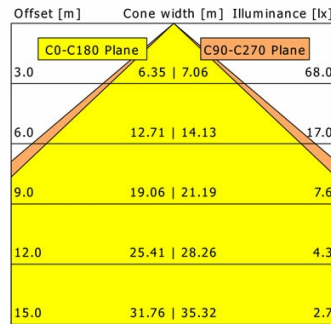

η	LED
Efficiency	144 lm/W
Direct/Indirect	↓ 100% / ↑ 0%
System Power	10 W
UGR	X=4H, Y=8H
Reflection factors	70/50/20
UGR C0/C180	25.0
UGR C90/C270	25.1
CIE Flux Codes	52 82 96 100 100
Ra/CRI	>80

LTS

LK-L 045.10840.0705.1/DALI

Lichtkanal 045 | Light-Insert (AOV-001/003/005.1, 1xLED 10W 840/4000K 1440lm)

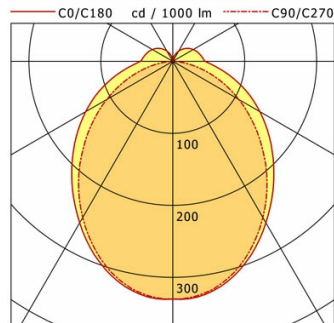

	C0	C90	C180	C270
0°	330	330	330	330
30°	259	251	259	251
60°	140	106	140	106
90°	45	1	45	1
120°	33	0	33	0
150°	16	1	16	1
180°	1	1	1	1
cd / 1000 lm				

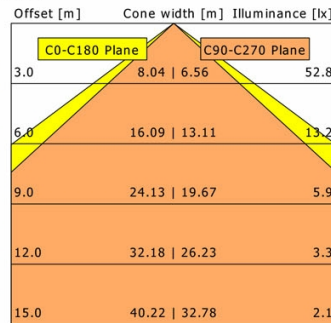

η	LED
Efficiency	144 lm/W
Direct/Indirect	↓ 89% / ↑ 11%
System Power	10 W
UGR	X=4H, Y=8H
Reflection factors	70/50/20
UGR C0/C180	26.9
UGR C90/C270	23.6
CIE Flux Codes	47 76 92 89 100
Ra/CRI	>80

LTS

LK-L 045.10840.0705.1/DALI

Lichtkanal 045 | Light-Insert (APB, 1xLED 10W 840/4000K 1480lm)

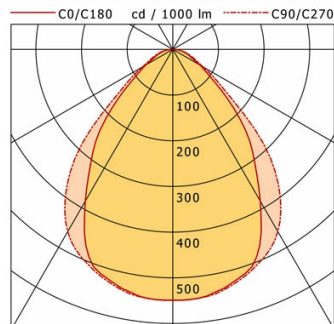

	C0	C90	C180	C270
0°	549	549	549	549
15°	525	529	525	529
30°	384	461	384	461
45°	199	267	199	267
60°	69	76	69	76
75°	27	32	27	32
90°	0	0	0	0
cd / 1000 lm				

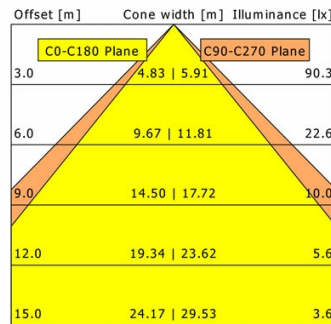

η	LED
Efficiency	148 lm/W
Direct/Indirect	↓ 100% / ↑ 0%
System Power	10 W
UGR	X=4H, Y=8H
Reflection factors	70/50/20
UGR C0/C180	21.5
UGR C90/C270	22.1
CIE Flux Codes	67 91 98 100 100
Ra/CRI	>80

LTS

LK-L 045.10840.0705.1/DALI

Lichtkanal 045 | Light-Insert (AOV-002/005.2, 1xLED 10W 840/4000K 1440lm)

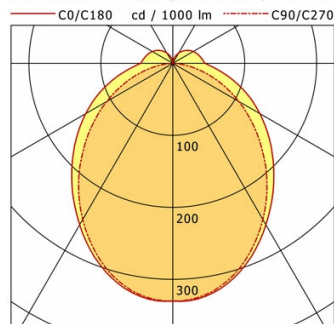

	C0	C90	C180	C270
0°	330	330	330	330
30°	259	251	259	251
60°	140	106	140	106
90°	45	1	45	1
120°	33	0	33	0
150°	16	1	16	1
180°	1	1	1	1
cd / 1000 lm				

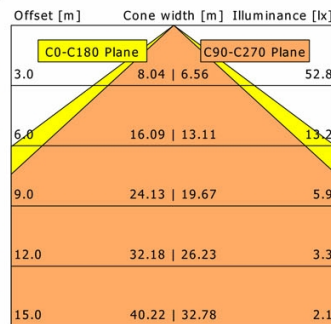

η	LED
Efficiency	144 lm/W
Direct/Indirect	↓ 89% / ↑ 11%
System Power	10 W
UGR	X=4H, Y=8H
Reflection factors	70/50/20
UGR C0/C180	26.9
UGR C90/C270	23.6
CIE Flux Codes	47 76 92 89 100
Ra/CRI	>80

LTS