

# SCEKLP 6.3040.45/DALI

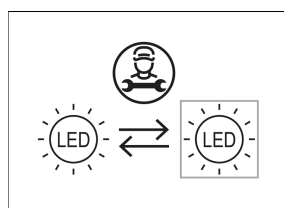

Colori	Articolo n.	EAN
nero	645184	4043544517470
argento	645185	4043544517487
bianco	645186	4043544517494

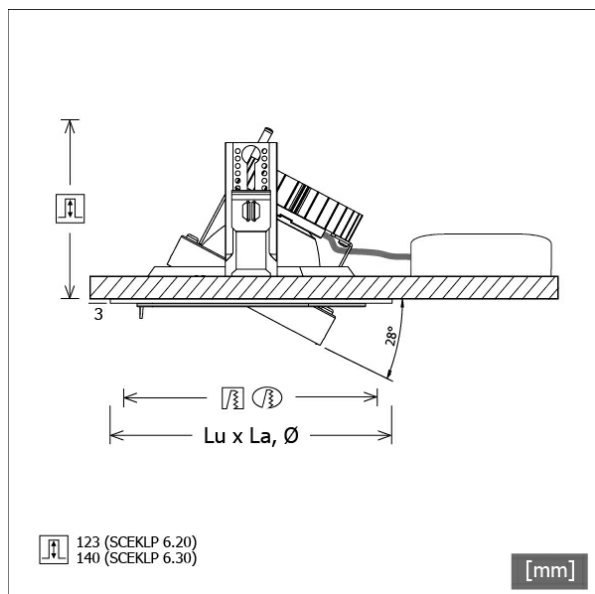

## Descrizione

- sistema di faretti da incasso flessibili costituito da cornici da incasso, teste lampada e alimentatori (cornici da incasso da ordinare separatamente)
- teste lampada direzionabili a 28° su giunti cardanici
- elevata facilità di manutenzione
- assenza di radiazioni termiche e UV
- gestione termica con raffreddamento passivo (termodispersore in alluminio)
- sospensioni cardaniche in pressofusione di zinco e policarbonato
- riflettore a specchio in alluminio con curva fotometrica simmetrica precisa per un'alta resa luminosa e il controllo ottimale dell'abbagliamento
- vetro di protezione trasparente
- innesto della testa lampada nella cornice da incasso senza attrezzi
- collegamento all'alimentatore tramite cavo lampada con connettore Mini-Clamp
- alimentatore (convertitore LED DALI, dimmerabile) incluso (posizionamento esterno)

## Opzioni standard



## Opzioni speciali



## Dati illuminotecnici / Norme

<b>Lampade</b>	LED Spot / CRI 80 / 4000 K
<b>EPREL fonti luminose</b>	851282
<b>Durata</b>	L90 B50 50.000 h L80 B50 100.000 h L80 B20 50.000 h
<b>Prestazioni sistema</b>	32.8 W
<b>Flusso luminoso apparecchio</b>	3710 lm
<b>Efficienza sistema</b>	113.10 lm/W
<b>Efficienza del modulo</b>	162.17 lm/W
<b>UGR classe</b>	≤22
<b>Zona di fascio luminoso</b>	Wide Flood
<b>Angolo del fascio luminoso</b>	49°
<b>Tensione di alimentazione</b>	220 - 240 V / 50 - 60 Hz
<b>Classe di protezione</b>	III
<b>Tipo di protezione</b>	IP20

## Dimensioni / pesi

<b>Altezza</b>	143 mm
<b>Profondità di incasso</b>	140 mm
<b>Diametro testa lampada</b>	154 mm
<b>Peso netto</b>	1.00 kg
<b>Peso lordo</b>	1.05 kg

# SCEKLP 6.3040.45/DALI

## SCEKLP 6.3040.45/DALI

Scene 6 System | Light-Head (1xLED 33W 840/4000K 3710lm)

C0/C180 cd / 1000 lm

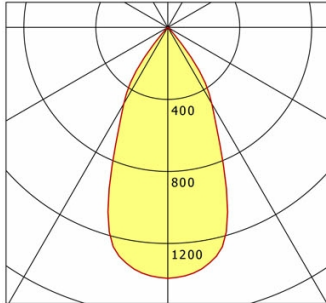

	C0	C90	C180	C270
0°	1394	1394	1394	1394
15°	1222	1222	1222	1222
30°	489	489	489	489
45°	18	18	18	18
60°	2	2	2	2
75°	1	1	1	1
90°	0	0	0	0

cd / 1000 lm

Offset [m] Cone width [m] Illuminance [lx]

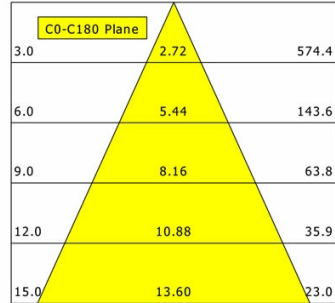

<b>η</b>	LED
Efficiency	113 lm/W
Direct/Indirect	↓ 100% / ↑ 0%
System Power	33 W
<b>UGR</b>	X=4H, Y=8H
Reflection factors	70/50/20
UGR C0/C180	21.2
UGR C90/C270	21.2
CIE Flux Codes	98 100 100 100 100
Ra/CRI	>80

LTS

## Accessori

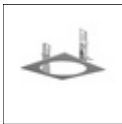

**SCER 6.100**  
Cornice da incasso 1 punto luce



**SCER 6.111**  
Cornice da incasso (rotonda) 1 punto luce

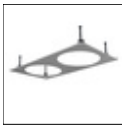

**SCER 6.200**  
Cornice da incasso 2 punti luce

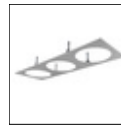

**SCER 6.300**  
Cornice da incasso 3 punti luce

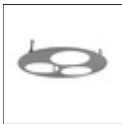

**SCER 6.310**  
Cornice da incasso (rotonda) 3 punti luce

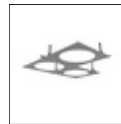

**SCER 6.330**  
Cornice angolare a incasso a 3 punti luce

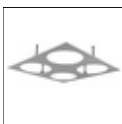

**SCER 6.400**  
Cornice da incasso 4 punti luce



**ZB-OR DONGLE**  
Organic Response Kit dongle IR



**ZB-OR GATEWAY**  
Organic Response serie a cascata gateway IoT



**ZB-OR-R SENSOR**  
sensore Organic Response per montaggio a incasso