

# FLIR 400.2030.01/DALI

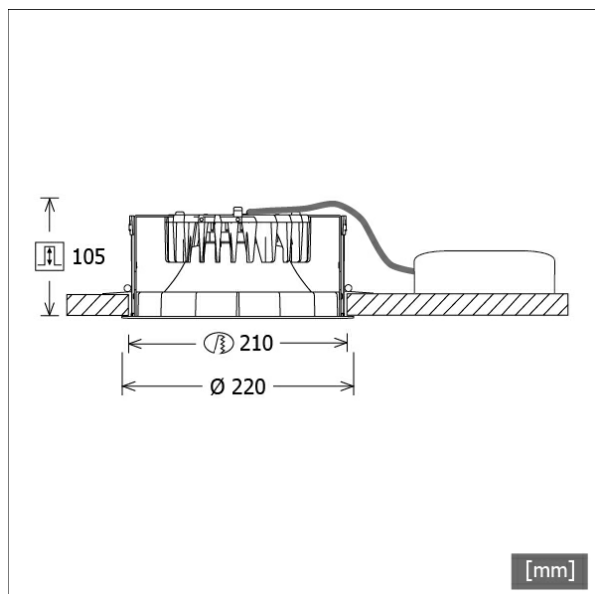

Colori	Articolo n.	EAN
nero	636664	4043544392466
argento	636665	4043544392473
bianco	636666	4043544392480



## Descrizione

- faretto a incasso con varianti di design ottico per illuminazione generale
- elevata facilità di manutenzione
- assenza di radiazioni termiche e UV
- gestione termica innovativa con raffreddamento passivo (termodispersore in pressofusione di alluminio)
- riflettore a specchio in alluminio ad alte prestazioni con curva fotometrica simmetrica precisa per la massima resa luminosa e il controllo ottimale dell'abbagliamento
- anello frontale/di montaggio in pressofusione di zinco con cornice a effetto luce trasparente (altri anelli decorativi/a effetto luce e vetri decorativi sono disponibili su richiesta)
- montaggio a soffitto senza attrezzi con dispositivo automatico di serraggio (regolazione automatica dello spessore del soffitto)
- Leuchte und Betriebsgerät über Kabel (Länge: 500 mm) fest verbunden, Betriebsgerät fertig für Netzanschluss
- alimentatore (convertitore LED DALI, dimmerabile) incluso (posizionamento esterno)

## Opzioni standard



## Opzioni speciali



## Dati illuminotecnici / Norme

Lampade	LED Modul / CRI 80 / 3000 K
EPREL fonti luminose	891015
	L90 B50 50.000 h
Durata	L80 B50 100.000 h
	L80 B20 50.000 h
Prestazioni sistema	21.0 W
Flusso luminoso apparecchio	max. 2170 lm
Efficienza sistema	99.04 lm/W
Efficienza del modulo	116.61 lm/W
UGR classe	≤25
Angolo del fascio luminoso	75°
Tensione di alimentazione	220 - 240 V / 50 - 60 Hz
Classe di protezione	II
Tipo di protezione	IP20

## Dimensioni / pesi

Diametro esterno	220 mm
Altezza	107 mm
Dimensione foro (Ø)	210 mm
Spessore soffitto	5.0 - 50.0 mm
Profondità di incasso	105 mm
Peso netto	1.26 kg
Peso lordo	1.33 kg

# FLIR 400.2030.01/DALI

Flixx 400 Round (FLIRZ 400.24, 1xLED 21W 830/3000K 2080lm 75 °)

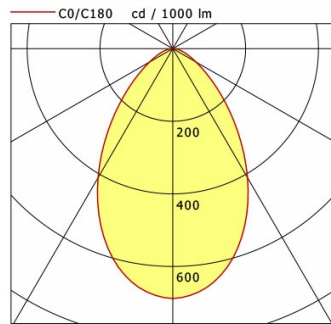

	C0	C90	C180	C270
0°	688	688	688	688
15°	610	610	610	610
30°	410	410	410	410
45°	197	197	197	197
60°	74	74	74	74
75°	26	26	26	26
90°	0	0	0	0

cd / 1000 lm

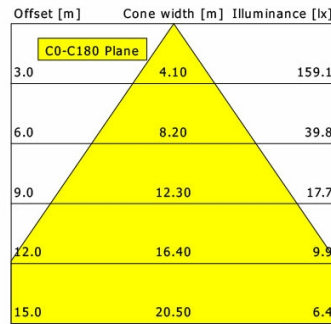

<b>η</b>	LED
Efficiency	99 lm/W
Direct/Indirect	↓ 100% / ↑ 0%
System Power	21 W
<b>UGR</b>	X=4H, Y=8H
Reflection factors	70/50/20
UGR C0/C180	22.9
UGR C90/C270	22.9
CIE Flux Codes	69 91 98 100 100
Ra/CRI	>80

LTS

Flixx 400 Round (FLIRZ 400.05, 1xLED 21W 830/3000K 2170lm 75 °)

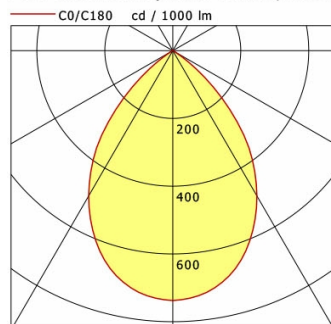

	C0	C90	C180	C270
0°	738	738	738	738
15°	677	677	677	677
30°	495	495	495	495
45°	221	221	221	221
60°	7	7	7	7
75°	4	4	4	4
90°	0	0	0	0

cd / 1000 lm

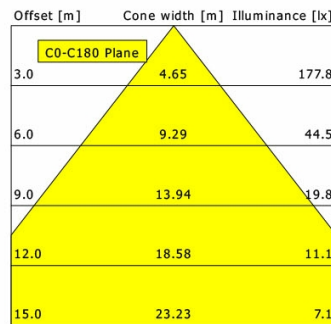

<b>η</b>	LED
Efficiency	103 lm/W
Direct/Indirect	↓ 100% / ↑ 0%
System Power	21 W
<b>UGR</b>	X=4H, Y=8H
Reflection factors	70/50/20
UGR C0/C180	19.6
UGR C90/C270	19.6
CIE Flux Codes	81 99 100 100 100
Ra/CRI	>80

LTS

Flixx 400 Round (FLIRZ 400.25, 1xLED 21W 830/3000K 2140lm 75 °)

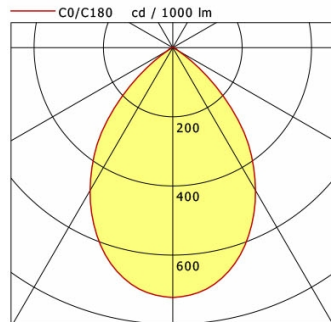

	C0	C90	C180	C270
0°	723	723	723	723
15°	658	658	658	658
30°	477	477	477	477
45°	223	223	223	223
60°	18	18	18	18
75°	8	8	8	8
90°	0	0	0	0

cd / 1000 lm

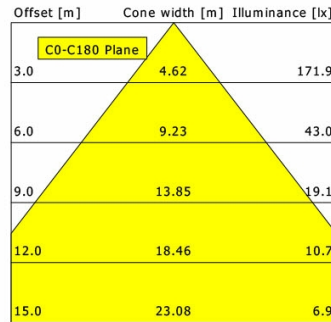

<b>η</b>	LED
Efficiency	102 lm/W
Direct/Indirect	↓ 100% / ↑ 0%
System Power	21 W
<b>UGR</b>	X=4H, Y=8H
Reflection factors	70/50/20
UGR C0/C180	19.9
UGR C90/C270	19.9
CIE Flux Codes	78 98 100 100 100
Ra/CRI	>80

LTS

# FLIRZ 400.2030.01/DALI

## Accessori



**FLIRZ 400.01**  
Anello decorativo nero



**FLIRZ 400.02**  
Anello decorativo argento



**FLIRZ 400.03**  
Anello decorativo bianco



**FLIRZ 400.04**  
Anello a effetto luce opale



**FLIRZ 400.05**  
Anello a effetto luce trasparente

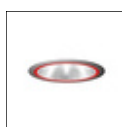

**FLIRZ 400.06**  
Anello a effetto luce rosso opaco



**FLIRZ 400.07**  
Anello a effetto luce giallo opaco



**FLIRZ 400.08**  
Anello a effetto luce blu opaco



**FLIRZ 400.16**  
Anello a effetto luce rosso traslucido



**FLIRZ 400.17**  
Anello a effetto luce giallo traslucido



**FLIRZ 400.18**  
Anello a effetto luce blu traslucido

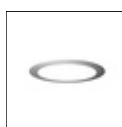

**FLIRZ 400.24**  
Vetro decorativo opale



**FLIRZ 400.25**  
Vetro decorativo trasparente



**NOL 50B/3H/DALI**  
Gruppo di emergenza LED



**ZB-OR DONGLE**  
Organic Response Kit dongle IR



**ZB-OR GATEWAY**  
Organic Response serie a cascata gateway IoT



**ZB-OR-R SENSOR**  
sensore Organic Response per montaggio a incasso



**ZVP 100**  
Cornice di rinforzo universale  
(modulo 625 x 625)