

SCEKLP 6.3040.35/DALI

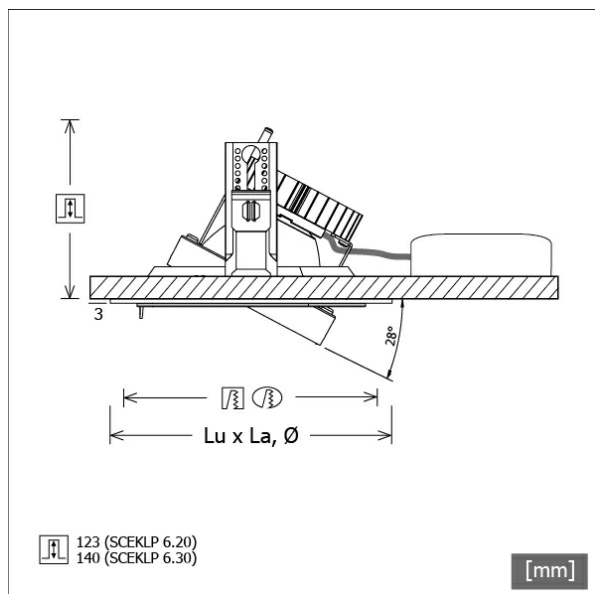

Colori	Articolo n.	EAN
nero	645181	4043544517449
argento	645182	4043544517456
bianco	645183	4043544517463



Descrizione

- sistema di faretti da incasso flessibili costituito da cornici da incasso, teste lampada e alimentatori (cornici da incasso da ordinare separatamente)
- teste lampada direzionabili a 28° su giunti cardanici
- elevata facilità di manutenzione
- assenza di radiazioni termiche e UV
- gestione termica con raffreddamento passivo (termodispersore in alluminio)
- sospensioni cardaniche in pressofusione di zinco e policarbonato
- riflettore a specchio in alluminio con curva fotometrica simmetrica precisa per un'alta resa luminosa e il controllo ottimale dell'abbagliamento
- vetro di protezione trasparente
- innesto della testa lampada nella cornice da incasso senza attrezzi
- collegamento all'alimentatore tramite cavo lampada con connettore Mini-Clamp
- alimentatore (convertitore LED DALI, dimmerabile) incluso (posizionamento esterno)

Opzioni standard



Opzioni speciali



Dati illuminotecnici / Norme

Lampade	LED Spot / CRI 80 / 4000 K
EPREL fonti luminose	851282
Durata	L90 B50 50.000 h
	L80 B50 100.000 h
	L80 B20 50.000 h
Prestazioni sistema	32.8 W
Flusso luminoso apparecchio	3740 lm
Efficienza sistema	114.02 lm/W
Efficienza del modulo	162.17 lm/W
UGR classe	≤22
Zona di fascio luminoso	Flood
Angolo del fascio luminoso	33°
Tensione di alimentazione	220 - 240 V / 50 - 60 Hz
Classe di protezione	III
Tipo di protezione	IP20

Dimensioni / pesi

Altezza	143 mm
Profondità di incasso	140 mm
Diametro testa lampada	154 mm
Peso netto	1.00 kg
Peso lordo	1.05 kg

SCEKLP 6.3040.35/DALI

SCEKLP 6.3040.35/DALI

Scene 6 System | Light-Head (1xLED 33W 840/4000K 3740lm)

C0/C180 cd / 1000 lm

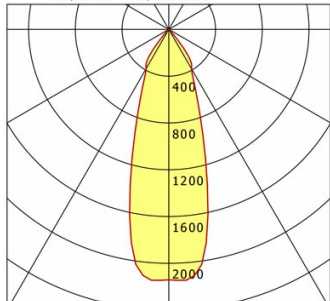

	C0	C90	C180	C270
0°	2141	2141	2141	2141
15°	1247	1247	1247	1247
30°	389	389	389	389
45°	18	18	18	18
60°	4	4	4	4
75°	0	0	0	0
90°	0	0	0	0

cd / 1000 lm

Offset [m] Cone width [m] Illuminance [lx]

Offset [m]	Cone width [m]	Illuminance [lx]
3.0	1.80	889.9
6.0	3.59	222.5
9.0	5.39	98.9
12.0	7.19	55.6
15.0	8.99	35.6

η	LED
Efficiency	113 lm/W
Direct/Indirect	↓ 100% / ↑ 0%
System Power	33 W
UGR	X=4H, Y=8H
Reflection factors	70/50/20
UGR C0/C180	20.7
UGR C90/C270	20.7
CIE Flux Codes	98 100 100 100 100
Ra/CRI	>80

LTS

Accessori



SCER 6.100
Cornice da incasso 1 punto luce



SCER 6.111
Cornice da incasso (rotonda) 1 punto luce

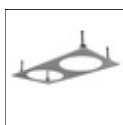

SCER 6.200
Cornice da incasso 2 punti luce

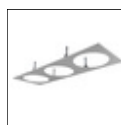

SCER 6.300
Cornice da incasso 3 punti luce



SCER 6.310
Cornice da incasso (rotonda) 3 punti luce



SCER 6.330
Cornice angolare a incasso a 3 punti luce

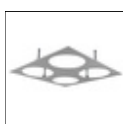

SCER 6.400
Cornice da incasso 4 punti luce



ZB-OR DONGLE
Organic Response Kit dongle IR



ZB-OR GATEWAY
Organic Response serie a cascata gateway IoT



ZB-OR-R SENSOR
sensore Organic Response per montaggio a incasso