

FLIR 400.3030.01/DALI

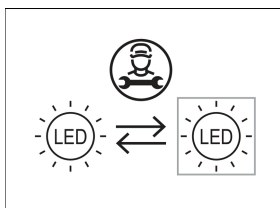

Colori	Articolo n.	EAN
nero	636676	4043544392589
argento	636677	4043544392596
bianco	636678	4043544392602

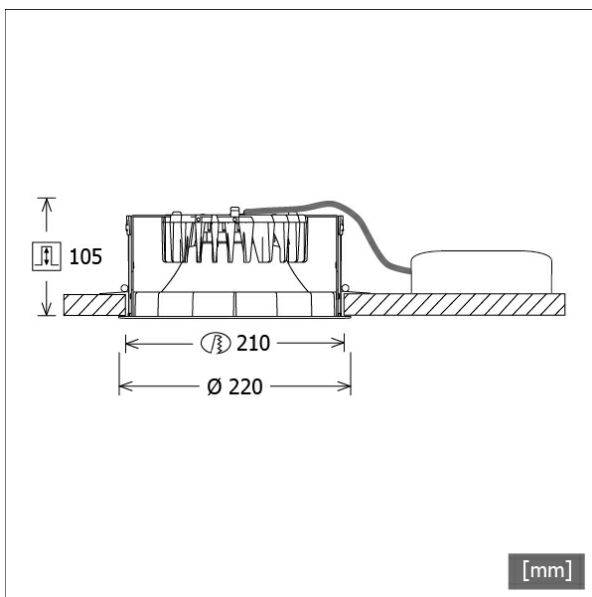

Descrizione

- faretto a incasso con varianti di design ottico per illuminazione generale
- elevata facilità di manutenzione
- assenza di radiazioni termiche e UV
- gestione termica innovativa con raffreddamento passivo (termodispersore in pressofusione di alluminio)
- riflettore a specchio in alluminio ad alte prestazioni con curva fotometrica simmetrica precisa per la massima resa luminosa e il controllo ottimale dell'abbagliamento
- anello frontale/di montaggio in pressofusione di zinco con cornice a effetto luce trasparente (altri anelli decorativi/a effetto luce e vetri decorativi sono disponibili su richiesta)
- montaggio a soffitto senza attrezzi con dispositivo automatico di serraggio (regolazione automatica dello spessore del soffitto)
- Leuchte und Betriebsgerät über Kabel (Länge: 500 mm) fest verbunden, Betriebsgerät fertig für Netzanschluss
- alimentatore (convertitore LED DALI, dimmerabile) incluso (posizionamento esterno)

Opzioni standard



Opzioni speciali



Dati illuminotecnici / Norme

Lampade	LED Modul / CRI 80 / 3000 K
EPREL fonti luminose	891018
	L90 B50 50.000 h
Durata	L80 B50 100.000 h
	L80 B20 50.000 h
Prestazioni sistema	26.0 W
Flusso luminoso apparecchio	max. 2870 lm
Efficienza sistema	110.38 lm/W
Efficienza del modulo	119.10 lm/W
UGR classe	≤25
Angolo del fascio luminoso	75°
Tensione di alimentazione	220 - 240 V / 50 - 60 Hz
Classe di protezione	II
Tipo di protezione	IP20

Dimensioni / pesi

Diametro esterno	220 mm
Altezza	107 mm
Dimensione foro (Ø)	210 mm
Spessore soffitto	5.0 - 50.0 mm
Profondità di incasso	105 mm
Peso netto	1.26 kg
Peso lordo	1.33 kg

FLIR 400.3030.01/DALI

Flixx 400 Round (FLIRZ 400.05, 1xLED 26W 830/3000K 2870lm 75 °)

C0/C180 cd / 1000 lm

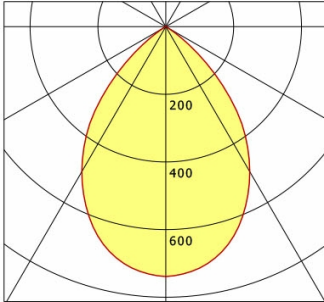

	C0	C90	C180	C270
0°	739	739	739	739
15°	678	678	678	678
30°	495	495	495	495
45°	220	220	220	220
60°	7	7	7	7
75°	4	4	4	4
90°	0	0	0	0
cd / 1000 lm				

Offset [m] Cone width [m] Illuminance [lx]

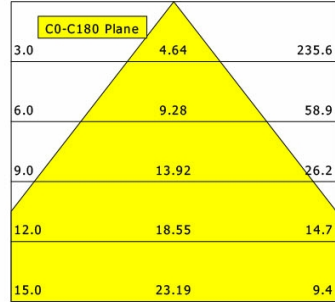

η	LED
Efficiency	110 lm/W
Direct/Indirect	↓ 100% / ↑ 0%
System Power	26 W
UGR	X=4H, Y=8H
Reflection factors	70/50/20
UGR C0/C180	20.5
UGR C90/C270	20.5
CIE Flux Codes	81 99 100 100 100
Ra/CRI	>80

LTS

Flixx 400 Round (FLIRZ 400.24, 1xLED 26W 830/3000K 2740lm 75 °)

C0/C180 cd / 1000 lm

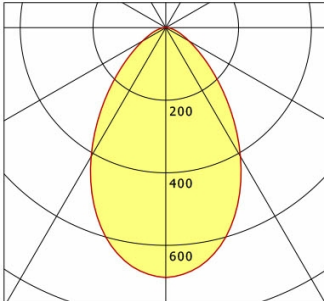

	C0	C90	C180	C270
0°	689	689	689	689
15°	610	610	610	610
30°	410	410	410	410
45°	197	197	197	197
60°	74	74	74	74
75°	26	26	26	26
90°	0	0	0	0
cd / 1000 lm				

Offset [m] Cone width [m] Illuminance [lx]

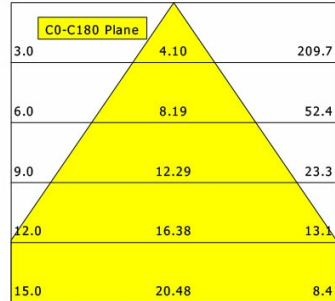

η	LED
Efficiency	105 lm/W
Direct/Indirect	↓ 100% / ↑ 0%
System Power	26 W
UGR	X=4H, Y=8H
Reflection factors	70/50/20
UGR C0/C180	23.8
UGR C90/C270	23.8
CIE Flux Codes	69 91 98 100 100
Ra/CRI	>80

LTS

Flixx 400 Round (FLIRZ 400.25, 1xLED 26W 830/3000K 2820lm 75 °)

C0/C180 cd / 1000 lm

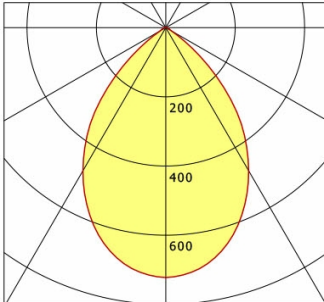

	C0	C90	C180	C270
0°	722	722	722	722
15°	657	657	657	657
30°	478	478	478	478
45°	222	222	222	222
60°	19	19	19	19
75°	8	8	8	8
90°	0	0	0	0
cd / 1000 lm				

Offset [m] Cone width [m] Illuminance [lx]

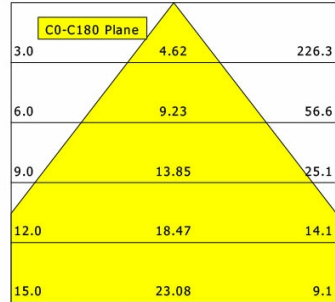

η	LED
Efficiency	108 lm/W
Direct/Indirect	↓ 100% / ↑ 0%
System Power	26 W
UGR	X=4H, Y=8H
Reflection factors	70/50/20
UGR C0/C180	20.9
UGR C90/C270	20.9
CIE Flux Codes	78 98 100 100 100
Ra/CRI	>80

LTS

FLIRZ 400.3030.01/DALI

Accessori



FLIRZ 400.01
Anello decorativo nero



FLIRZ 400.02
Anello decorativo argento



FLIRZ 400.03
Anello decorativo bianco



FLIRZ 400.04
Anello a effetto luce opale



FLIRZ 400.05
Anello a effetto luce trasparente



FLIRZ 400.06
Anello a effetto luce rosso opaco



FLIRZ 400.07
Anello a effetto luce giallo opaco



FLIRZ 400.08
Anello a effetto luce blu opaco



FLIRZ 400.16
Anello a effetto luce rosso traslucido



FLIRZ 400.17
Anello a effetto luce giallo traslucido



FLIRZ 400.18
Anello a effetto luce blu traslucido

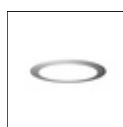

FLIRZ 400.24
Vetro decorativo opale



FLIRZ 400.25
Vetro decorativo trasparente



NOL 50B/3H/DALI
Gruppo di emergenza LED



ZB-OR DONGLE
Organic Response Kit dongle IR



ZB-OR GATEWAY
Organic Response serie a cascata gateway IoT



ZB-OR-R SENSOR
sensore Organic Response per montaggio a incasso



ZVP 100
Cornice di rinforzo universale
(modulo 625 x 625)