

LK-L 045.11840.1685.1/DALI



Descrizione

- inserto modulo in lamiera d'acciaio con moduli LED integrati
- assenza di radiazioni termiche e UV
- si possono realizzare strisce di qualsiasi lunghezza
- set di cavi incluso (a 5 poli)
- diffusore curvo in PMMA per una diffusione omogenea della luce
- innesto nel profilo senza attrezzi
- morsetto a 5 poli, preassemblato per cablaggio passante a 5 poli
- alimentatore (convertitore LED DALI, dimmerabile) integrato

Note

La dilatazione termica lineare del profilo di alluminio a dT = 10 Kelvin è di 0,3 mm al metro.

Opzioni standard



Opzioni speciali



Colori	Articolo n.	EAN
	669422	4043544810984

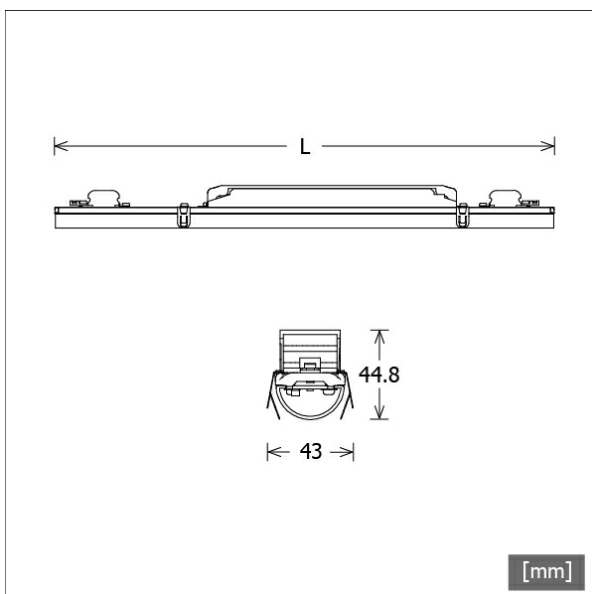

Dati illuminotecnici / Norme

Lampade	LED linear / CRI 80 / 4000 K
Durata	L90 B50 50.000 h L80 B50 100.000 h L80 B20 50.000 h
Prestazioni sistema	37.8 W
Flusso luminoso apparecchio	max. 5620 lm
Efficienza sistema	140.74 lm/W
Efficienza del modulo	205.00 lm/W
UGR classe	≤28
Tensione di alimentazione	220 - 240 V / 50 - 60 Hz
Classe di protezione	I

Dimensioni / pesi

Lunghezza	1685 mm
Larghezza	43 mm
Altezza	44 mm
Peso netto	1.57 kg
Peso lordo	1.82 kg

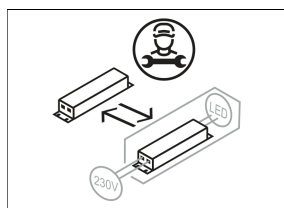
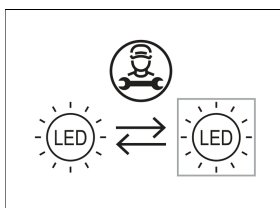

LK-L 045.11840.1685.1/DALI

LK-L 045.11840.1685.1/DALI

Lichtkanal 045 | Light-Insert (AOV-001/003/005.1, 1xLED 38W 840/4000K 5320lm)

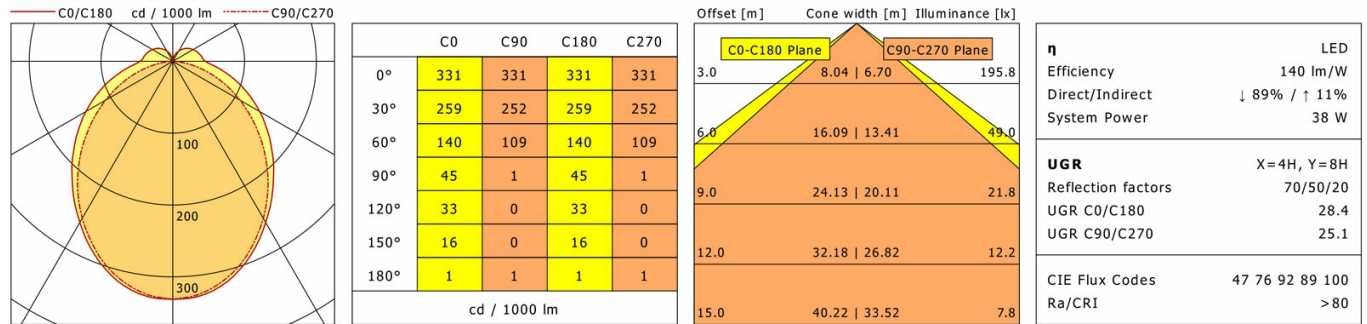

LTS

LK-L 045.11840.1685.1/DALI

Lichtkanal 045 | Light-Insert (AOV-002/005.2, 1xLED 38W 840/4000K 5320lm)

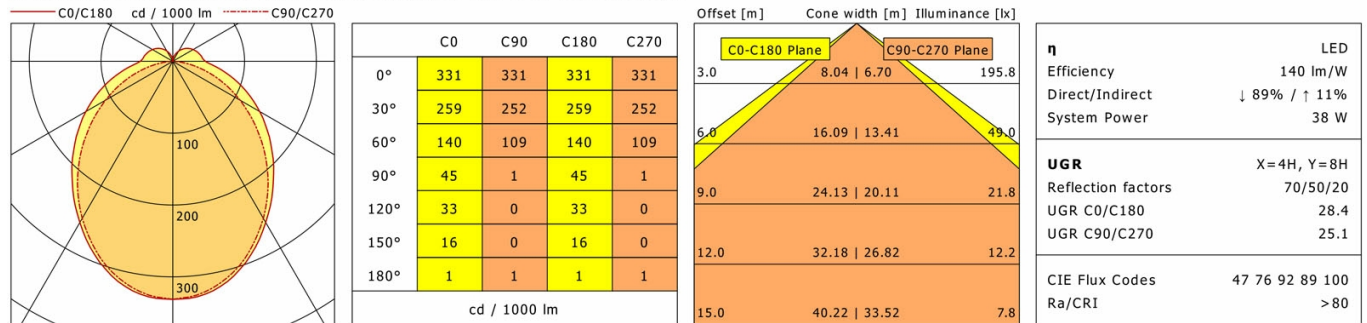

LTS

LK-L 045.11840.1685.1/DALI

Lichtkanal 045 | Light-Insert (APB, 1xLED 38W 840/4000K 5390lm)

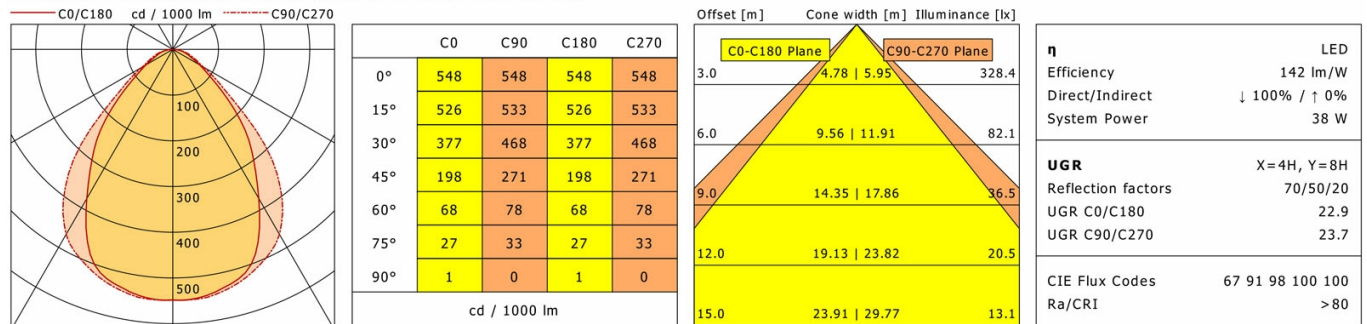

LTS

LK-L 045.11840.1685.1/DALI

Lichtkanal 045 | Light-Insert (AOB, 1xLED 38W 840/4000K 5620lm)

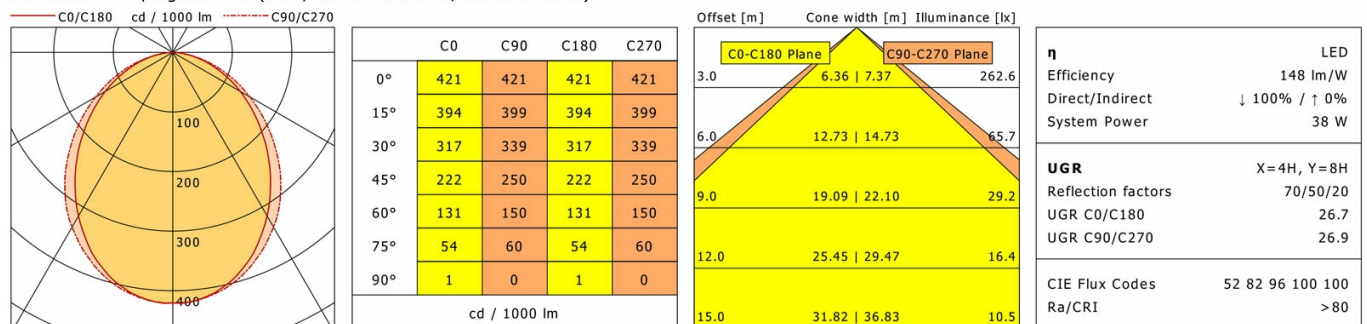

LTS