

SCEKLP 6.3040.25/DALI

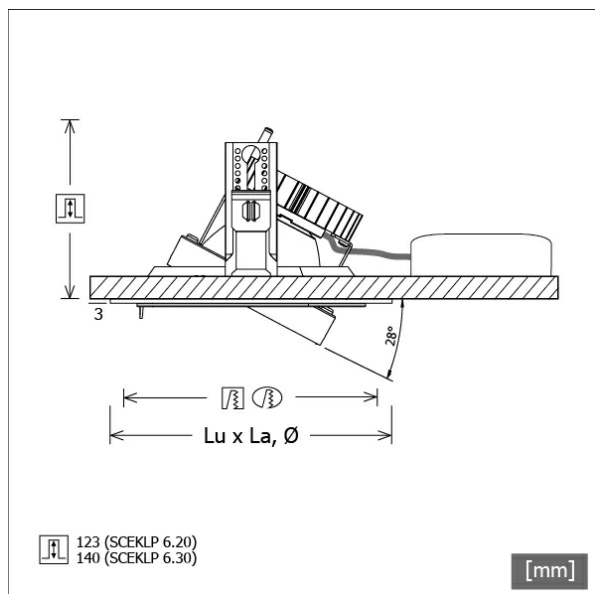

Colori	Articolo n.	EAN
nero	645178	4043544517418
argento	645179	4043544517425
bianco	645180	4043544517432



Descrizione

- sistema di faretti da incasso flessibili costituito da cornici da incasso, teste lampada e alimentatori (cornici da incasso da ordinare separatamente)
- teste lampada direzionabili a 28° su giunti cardanici
- elevata facilità di manutenzione
- assenza di radiazioni termiche e UV
- gestione termica con raffreddamento passivo (termodispersore in alluminio)
- sospensioni cardaniche in pressofusione di zinco e policarbonato
- riflettore a specchio in alluminio con curva fotometrica simmetrica precisa per un'alta resa luminosa e il controllo ottimale dell'abbagliamento
- vetro di protezione trasparente
- innesto della testa lampada nella cornice da incasso senza attrezzi
- collegamento all'alimentatore tramite cavo lampada con connettore Mini-Clamp
- alimentatore (convertitore LED DALI, dimmerabile) incluso (posizionamento esterno)

Opzioni standard



Opzioni speciali



Dati illuminotecnici / Norme

Lampade	LED Spot / CRI 80 / 4000 K
EPREL fonti luminose	851282
Durata	L90 B50 50.000 h
	L80 B50 100.000 h
	L80 B20 50.000 h
Prestazioni sistema	32.8 W
Flusso luminoso apparecchio	3760 lm
Efficienza sistema	114.63 lm/W
Efficienza del modulo	162.17 lm/W
UGR classe	≤22
Zona di fascio luminoso	Medium Flood
Angolo del fascio luminoso	27°
Tensione di alimentazione	220 - 240 V / 50 - 60 Hz
Classe di protezione	III
Tipo di protezione	IP20

Dimensioni / pesi

Altezza	143 mm
Profondità di incasso	140 mm
Diametro testa lampada	154 mm
Peso netto	1.00 kg
Peso lordo	1.05 kg

SCEKLP 6.3040.25/DALI

SCEKLP 6.3040.25/DALI

Scene 6 System | Light-Head (1xLED 33W 840/4000K 3760lm)

C0/C180 cd / 1000 lm

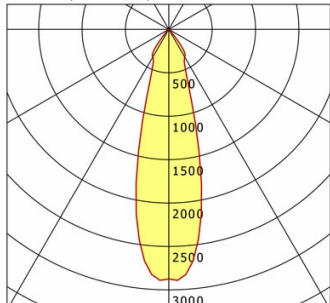

	C0	C90	C180	C270
0°	2875	2875	2875	2875
15°	1264	1264	1264	1264
30°	369	369	369	369
45°	19	19	19	19
60°	3	3	3	3
75°	0	0	0	0
90°	0	0	0	0

cd / 1000 lm

Offset [m] Cone width [m] Illuminance [lx]

Offset [m]	Cone width [m]	Illuminance [lx]
3.0	1.50	1201.0
6.0	3.00	300.2
9.0	4.50	133.4
12.0	6.00	75.1
15.0	7.50	48.0

η	LED
Efficiency	114 lm/W
Direct/Indirect	↓ 100% / ↑ 0%
System Power	33 W
UGR	X=4H, Y=8H
Reflection factors	70/50/20
UGR C0/C180	20.3
UGR C90/C270	20.3
CIE Flux Codes	98 100 100 100 100
Ra/CRI	>80

LTS

Accessori



SCER 6.100
Cornice da incasso 1 punto luce



SCER 6.111
Cornice da incasso (rotonda) 1 punto luce

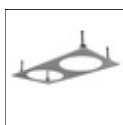

SCER 6.200
Cornice da incasso 2 punti luce

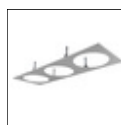

SCER 6.300
Cornice da incasso 3 punti luce



SCER 6.310
Cornice da incasso (rotonda) 3 punti luce



SCER 6.330
Cornice angolare a incasso a 3 punti luce

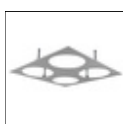

SCER 6.400
Cornice da incasso 4 punti luce



ZB-OR DONGLE
Organic Response Kit dongle IR



ZB-OR GATEWAY
Organic Response serie a cascata gateway IoT



ZB-OR-R SENSOR
sensore Organic Response per montaggio a incasso