

**D**

**Hinweise:**

- Allgemeines Hinweisblatt 818278 beachten.
- Einbauraum und Abstandsmaße gemäß Abbildung ③ beachten. Die Leuchten JETT-R 106... dürfen nur in offene Deckensysteme eingebaut werden.
- Abmessungen und Einbaumaße in [mm].

**Einbaumaße:**

**GB**

**Notes:**

- Consider the general notes 818278.
- Consider installation room and distances according figure ③. The luminaires JETT-R 106... must only be installed in open ceiling systems.
- Dimensions and mounting measurements in [mm].

**Mounting Dimensions:**

Bezeichnung / type	Einbautiefe / Installation depth (ET)	Ausschnitt / cut-out (DA)	Deckenstärke / ceiling thickness (DS)
JETT-R...	195	Ø 145 - 160	5 - 50

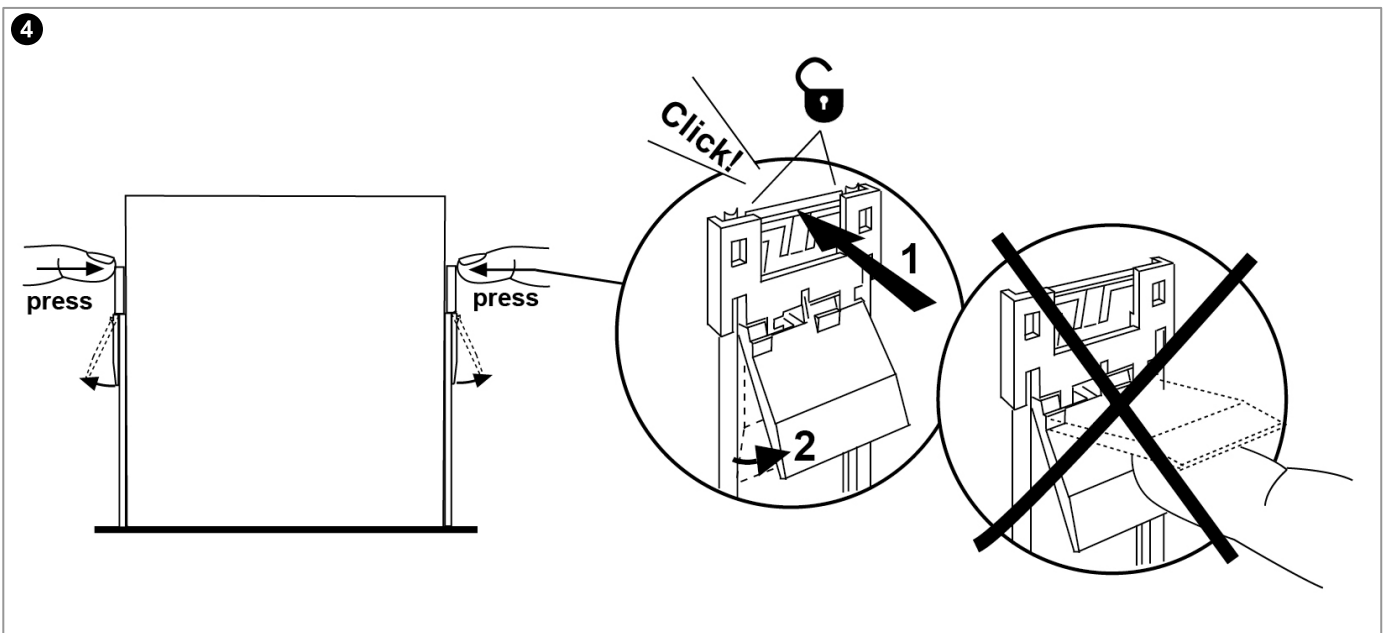
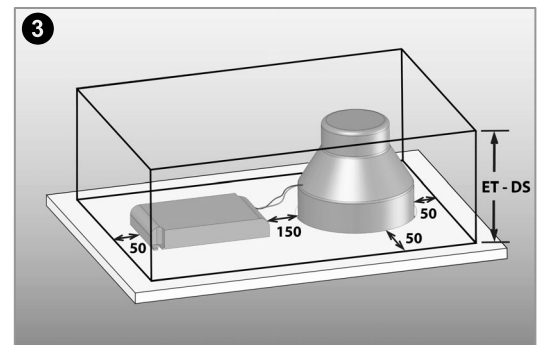
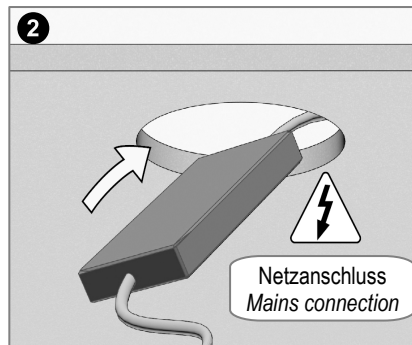
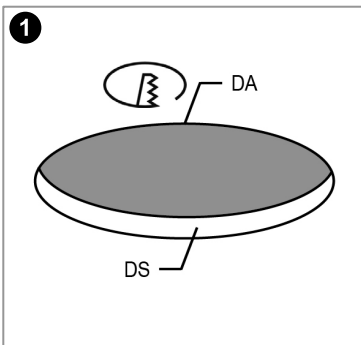

**5 Einbau / Mounting procedure**

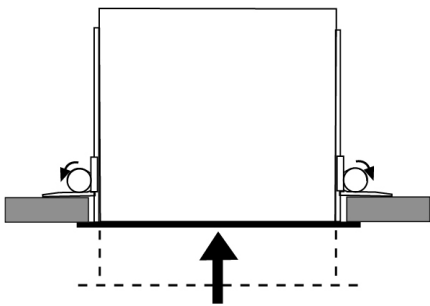
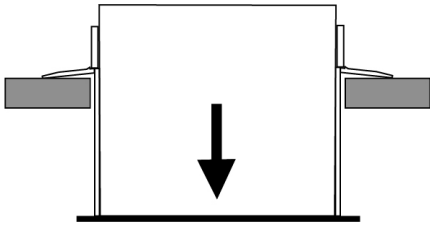
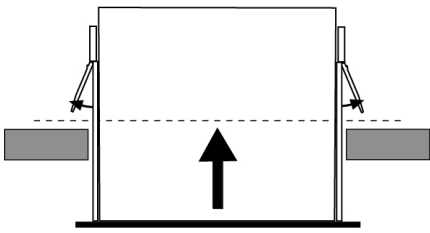
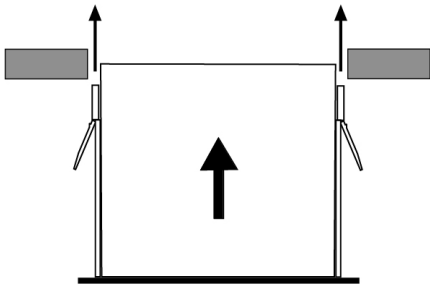

**6 Ausbau / Removing procedure**

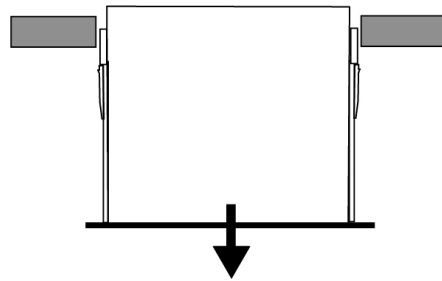
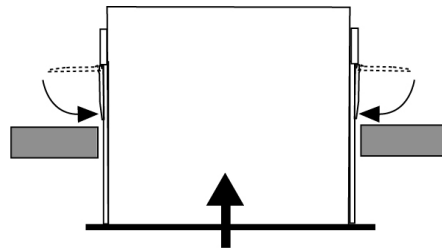
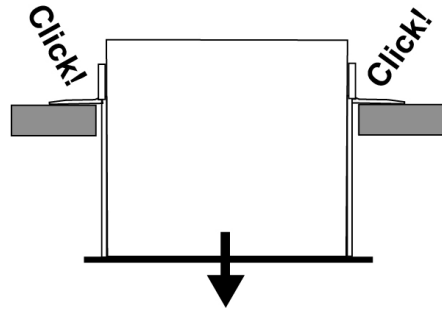
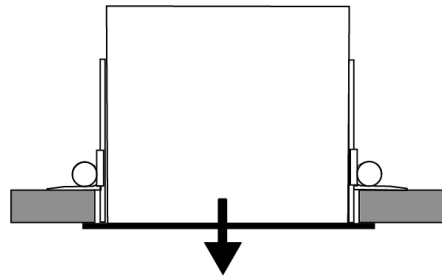

D

▪ **Angaben auf Versorgungseinheit beachten.**

- Anschluss darf nur an geeignete LTS-Versorgungseinheiten erfolgen.

-  Netzanschluss muss bauseitig gemäß der geforderten Schutzart und Schutzklasse vorhanden sein. **Netzanschluss darf nur von Elektrofachkräften durchgeführt werden.** Örtliche Vorschriften beachten.

- Anschlussleitungen nicht über Versorgungseinheit führen.

- Versorgungseinheit nicht mit Wärmedämm-Material abdecken.



GB

**Consider the information on the ballasts.**

*Connection must only be done to suitable LTS ballasts.*

-  *Mains connection must be provided on-site according the required protection type and class. **Mains connection must only be done by electricians.** Consider local regulations.*

*Don't lead the connecting lines across the ballast.*

*Do not cover ballast with warmth insulation material.*



**D**

**GB**

- Hinweisblatt 818278 und dazugehörige Montageanweisungen beachten.

Consider the notes 818278 and the corresponding installation instructions.

