

JETT-T 103.930.WF



Beschreibung

- flexibler Stromschienenstrahler in getrennter Bauform mit zylinderförmigem Lichtkopf
- Leuchte 355° drehbar und Lichtkopf 180° schwenkbar
- hohe Wartungsfreundlichkeit
- keine UV- und Wärmestrahlung
- Lichtkopf aus Aluminiumdruckguss
- innovatives Wärmemanagement mit formintegrierter Passivkühlung
- High-Performance Spiegelreflektor aus Aluminium mit präziser symmetrischer Abstrahlcharakteristik für optimale Lichtausbeute und Entblendung
- Gehäuse für Betriebsgerät aus Stahlblech
- Schutzglas klar
- 3-Phasen-Stromschienenadapter
- Betriebsgerät (LED-Konverter) integriert

Standardoptionen



Sonderoptionen



Farbe	Artikelnummer	EAN
silber	668487	4043544801494
schwarz	668488	4043544801500
weiß	668489	4043544801517

Lichttechnik / Normen

Leuchtmittel	LED Spot / CRI 90 / 3000 K
EPREL Lichtquellen	1024000
Lebensdauer	L90 B50 50.000 h L80 B50 100.000 h L80 B20 50.000 h
Systemleistung	24.1 W
Leuchten-Lichtstrom	3080 lm
Systemeffizienz	127.80 lm/W
Moduleffizienz	136.81 lm/W
UGR Klasse	≤22
Abstrahlbereich	Wide Flood
Abstrahlwinkel	50°
Versorgungsspannung	220 - 240 V / 50 - 60 Hz
Schutzklasse	I
Schutzart	IP20

Abmessungen / Gewichte

Länge	151 mm
Breite	103 mm
Höhe	170 mm
Durchmesser Lichtkopf	103 mm
Nettogewicht	1.28 kg
Bruttogewicht	1.35 kg

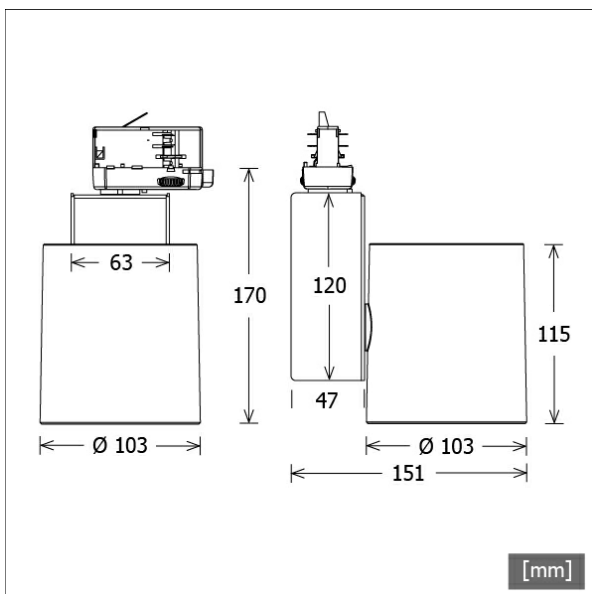

JETT-T 103.930.WF

JETT-T 103.930.WF

Jett Evo | Track-Mounted (1xLED 24W 930/3000K 3080lm 50°)

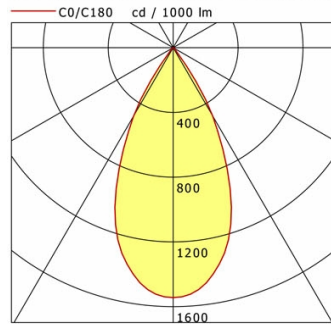

	C0	C90	C180	C270
0°	1544	1544	1544	1544
15°	1274	1274	1274	1274
30°	487	487	487	487
45°	18	18	18	18
60°	8	8	8	8
75°	2	2	2	2
90°	0	0	0	0
cd / 1000 lm				

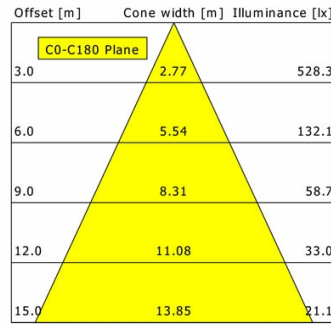

η	LED
Efficiency	128 lm/W
Direct/Indirect	↓ 100% / ↑ 0%
System Power	24 W
UGR	X=4H, Y=8H
Reflection factors	70/50/20
UGR C0/C180	19.6
UGR C90/C270	19.6
CIE Flux Codes	97 99 100 100 100
Ra/CRI	>90

LTS

Zubehör



FOCUS 100.1
fokussierbare Bikonvexlinse für Akzentbeleuchtung



ST-A 10/9000A-1-ST
Anbau-Stromschiene ONETrack Advance mit Datenbus
(Länge: 1000 mm)



ST-A 20/9000A-2-ST
Anbau-Stromschiene ONETrack Advance mit Datenbus
(Länge: 2000 mm)



ST-A 30/9000A-3-ST
Anbau-Stromschiene ONETrack Advance mit Datenbus
(Länge: 3000 mm)



ST-A 40/9000A-4-ST
Anbau-Stromschiene ONETrack Advance mit Datenbus
(Länge: 4000 mm)



ST-A MONO/9000-BPU-D
3-Phasen-Anbau-Monopoint mit Busoption



ST-E 10/9000-1-R
Einbau-Stromschiene ONETrack mit Datenbus
(Länge: 1000 mm)



ST-E 20/9000-2-R
Einbau-Stromschiene ONETrack mit Datenbus
(Länge: 2000 mm)



ST-E 30/9000-3-R
Einbau-Stromschiene ONETrack mit Datenbus
(Länge: 3000 mm)



ST-E 40/9000-4-R
Einbau-Stromschiene ONETrack mit Datenbus
(Länge: 4000 mm)



ST-E MONO/9000-BPU-D
3-Phasen-Einbau-Monopoint mit Busoption



ZBK 96
Blendklappe

Stromschienenstrahler · Jett Evo Stromschiene



JETT-T 103.930.WF

Zubehör



ZBW 83
Wabenraster