

# FLIR 200.2030.50/DALI

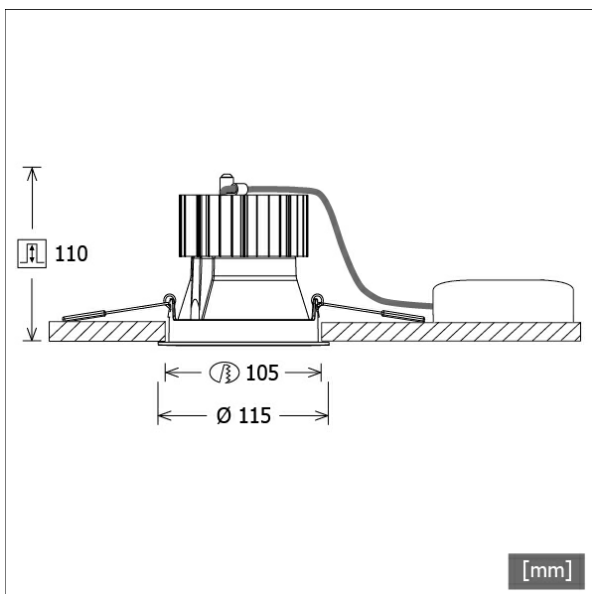

Farbe	Artikelnummer	EAN
schwarz	641756	4043544473028
silber	641757	4043544473035
weiß	641758	4043544473042



## Beschreibung

- Einbaustrahler mit optischen Designvarianten und breitem Anwendungsspektrum
- Lichtkopf 20° schwenkbar
- hohe Wartungsfreundlichkeit
- keine UV- und Wärmestrahlung
- Wärmemanagement mit Passivkühlung (Kühlkörper aus Aluminium)
- High-Performance Spiegelreflektor aus Aluminium mit präziser symmetrischer Abstrahlcharakteristik für maximale Lichtausbeute und optimale Entblendung
- Front-/Einbauring aus Zinkdruckguss mit Lichteffektring klar (weitere Dekor-/Lichteffektringe und Dekogläser sind als Option erhältlich)
- werkzeugloser Deckeneinbau mit Schnellspannfedern (automatische Anpassung der Deckenstärke)
- Leuchte und Betriebsgerät über Kabel (Länge: 500 mm) fest verbunden, Betriebsgerät fertig für Netzanschluss
- Betriebsgerät (LED-Konverter DALI, dimmbar) inklusive (Platzierung extern)

## Standardoptionen



## Sonderoptionen



## Lichttechnik / Normen

Leuchtmittel	LED Spot / CRI 80 / 3000 K
EPREL Lichtquellen	848117
Lebensdauer	L90 B50 50.000 h
	L80 B50 100.000 h
	L80 B20 50.000 h
Systemleistung	27,0 W
Leuchten-Lichtstrom	max. 2880 lm
Systemeffizienz	106,66 lm/W
Moduleffizienz	156,64 lm/W
UGR Klasse	≤28
Abstrahlbereich	Wide Flood
Abstrahlwinkel	51°
Versorgungsspannung	220 - 240 V / 50 - 60 Hz
Schutzklasse	II
Schutzart	IP20

## Abmessungen / Gewichte

Außendurchmesser	115 mm
Höhe	112 mm
Ausschnittsmaß (Ø)	105 mm
Deckenstärke	1,0 - 25,0 mm
Einbautiefe	110 mm
Nettogewicht	0,93 kg
Bruttogewicht	1,01 kg

# FLIR 200.2030.50/DALI

## FLIR 200.2030.50/DALI

Flixx 200 Round (FLIRZ 200.05, 1xLED 27W 830/3000K 2880lm 51°)

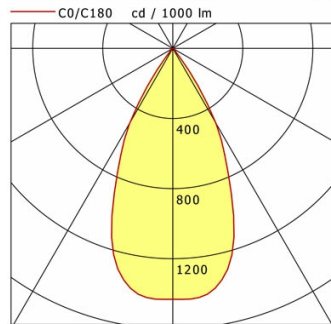

	C0	C90	C180	C270
0°	1431	1431	1431	1431
15°	1264	1264	1264	1264
30°	492	492	492	492
45°	17	17	17	17
60°	14	14	14	14
75°	6	6	6	6
90°	0	0	0	0
cd / 1000 lm				

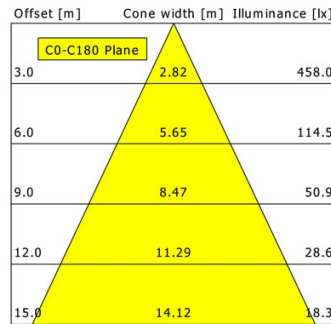

<b>η</b>	LED
Efficiency	107 lm/W
Direct/Indirect	↓ 100% / ↑ 0%
System Power	27 W
<b>UGR</b>	X=4H, Y=8H
Reflection factors	70/50/20
UGR C0/C180	21.4
UGR C90/C270	21.4
CIE Flux Codes	95 98 100 100 100
Ra/CRI	>80

LTS

## FLIR 200.2030.50/DALI

Flixx 200 Round (FLIRZ 200.24, 1xLED 27W 830/3000K 2710lm 51°)

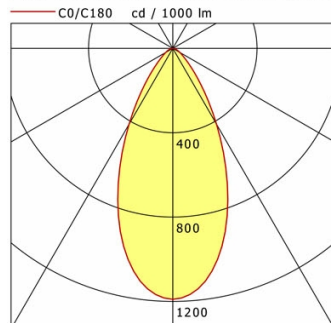

	C0	C90	C180	C270
0°	1190	1190	1190	1190
15°	936	936	936	936
30°	415	415	415	415
45°	116	116	116	116
60°	39	39	39	39
75°	16	16	16	16
90°	0	0	0	0
cd / 1000 lm				

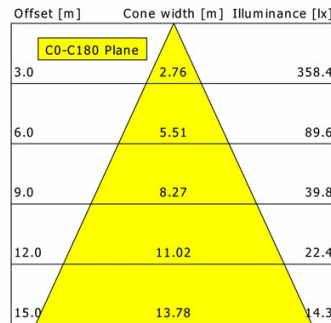

<b>η</b>	LED
Efficiency	100 lm/W
Direct/Indirect	↓ 100% / ↑ 0%
System Power	27 W
<b>UGR</b>	X=4H, Y=8H
Reflection factors	70/50/20
UGR C0/C180	26.4
UGR C90/C270	26.4
CIE Flux Codes	83 95 99 100 100
Ra/CRI	>80

LTS

## FLIR 200.2030.50/DALI

Flixx 200 Round (FLIRZ 200.25, 1xLED 27W 830/3000K 2800lm 51°)

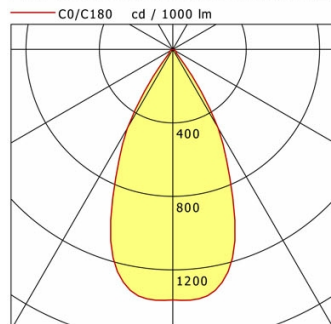

	C0	C90	C180	C270
0°	1364	1364	1364	1364
15°	1216	1216	1216	1216
30°	494	494	494	494
45°	27	27	27	27
60°	17	17	17	17
75°	6	6	6	6
90°	0	0	0	0
cd / 1000 lm				

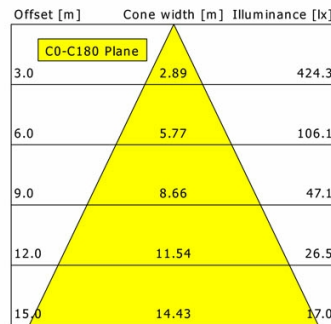

<b>η</b>	LED
Efficiency	104 lm/W
Direct/Indirect	↓ 100% / ↑ 0%
System Power	27 W
<b>UGR</b>	X=4H, Y=8H
Reflection factors	70/50/20
UGR C0/C180	21.6
UGR C90/C270	21.6
CIE Flux Codes	94 98 100 100 100
Ra/CRI	>80

LTS

# FLIRZ 200.2030.50/DALI

## Zubehör



**FLIRZ 200.01**  
Dekorring schwarz



**FLIRZ 200.02**  
Dekorring silber



**FLIRZ 200.03**  
Dekorring weiß



**FLIRZ 200.04**  
Lichteffektring opal



**FLIRZ 200.05**  
Lichteffektring klar



**FLIRZ 200.06**  
Lichteffektring rot matt



**FLIRZ 200.07**  
Lichteffektring gelb matt



**FLIRZ 200.08**  
Lichteffektring blau matt



**FLIRZ 200.16**  
Lichteffektring rot transluzent



**FLIRZ 200.17**  
Lichteffektring gelb transluzent



**FLIRZ 200.18**  
Lichteffektring blau transluzent

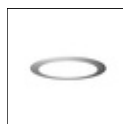

**FLIRZ 200.24**  
Dekoglas opal



**FLIRZ 200.25**  
Dekoglas klar



**ZB-OR DONGLE**  
Organic Response IR-Dongle-Set



**ZB-OR GATEWAY**  
Organic Response IoT-Gateway Kaskadenserie



**ZB-OR-R SENSOR**  
Organic Response Sensor für Einbaumontage