

SCEKLP 6.3040.15/DALI

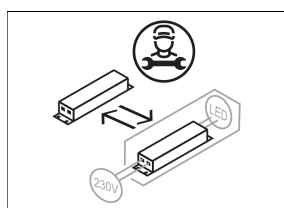

Farbe	Artikelnummer	EAN
schwarz	645175	4043544517388
silber	645176	4043544517395
weiß	645177	4043544517401

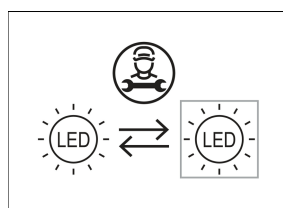
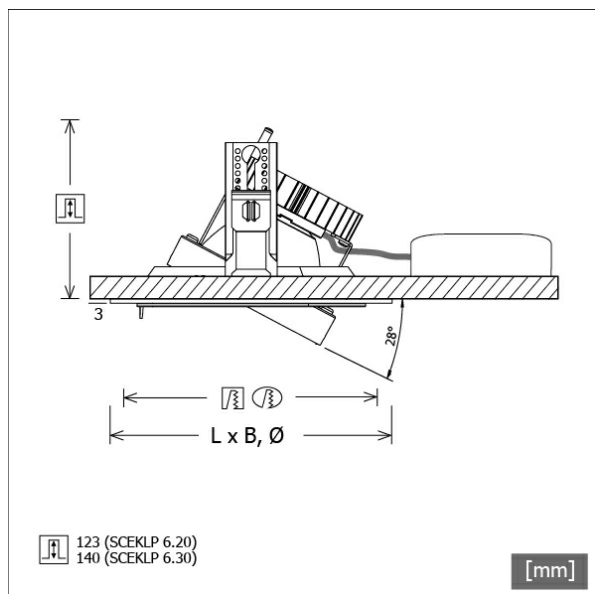

Beschreibung

- flexibles Einbaustrahlersystem bestehend aus Einbaurahmen, Lichtköpfen und Betriebsgeräten (Einbaurahmen separat bestellen)
- Lichtkopf 28° kardanisch schwenkbar
- hohe Wartungsfreundlichkeit
- keine UV- und Wärmestrahlung
- Wärmemanagement mit Passivkühlung (Kühlkörper aus Aluminium)
- Kardanringe aus Zinkdruckguss und Polycarbonat
- Spiegelreflektor aus Aluminium mit präziser symmetrischer Abstrahlcharakteristik für optimale Lichtausbeute und Entblendung
- Schutzglas klar
- werkzeugloses Einrasten des Lichtkopfes in Einbaurahmen
- Anschluss an Betriebsgerät über Leuchtenkabel mit Mini-Clamp Steckverbindung
- Betriebsgerät (LED-Konverter DALI, dimmbar) inklusive (Platzierung extern)

Standardoptionen



Sonderoptionen



Lichttechnik / Normen

Leuchtmittel	LED Spot / CRI 80 / 4000 K
EPREL Lichtquellen	851282
Lebensdauer	L90 B50 50.000 h
	L80 B50 100.000 h
	L80 B20 50.000 h
Systemleistung	32,8 W
Leuchten-Lichtstrom	3780 lm
Systemeffizienz	115,24 lm/W
Moduleffizienz	162,17 lm/W
UGR Klasse	≤22
Abstrahlbereich	Spot
Abstrahlwinkel	14°
Versorgungsspannung	220 - 240 V / 50 - 60 Hz
Schutzklasse	III
Schutzart	IP20

Abmessungen / Gewichte

Höhe	143 mm
Einbautiefe	140 mm
Durchmesser Lichtkopf	154 mm
Nettogewicht	1,00 kg
Bruttogewicht	1,05 kg

SCEKLP 6.3040.15/DALI

SCEKLP 6.3040.15/DALI

Scene 6 System | Light-Head (1xLED 33W 840/4000K 3780lm)

C0/C180 cd / 1000 lm

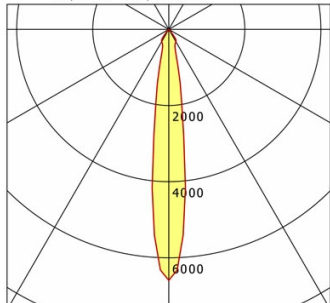

	C0	C90	C180	C270
0°	6592	6592	6592	6592
15°	829	829	829	829
30°	372	372	372	372
45°	18	18	18	18
60°	1	1	1	1
75°	0	0	0	0
90°	0	0	0	0
cd / 1000 lm				

Offset [m] Cone width [m] Illuminance [lx]

Offset [m]	Cone width [m]	Illuminance [lx]
3.0	0.76	2768.6
6.0	1.52	692.1
9.0	2.28	307.6
12.0	3.04	173.0
15.0	3.80	110.7

η	LED
Efficiency	115 lm/W
Direct/Indirect	↓ 100% / ↑ 0%
System Power	33 W
UGR	X=4H, Y=8H
Reflection factors	70/50/20
UGR C0/C180	20.2
UGR C90/C270	20.2
CIE Flux Codes	98 100 100 100 100
Ra/CRI	>80

LTS

Zubehör



SCER 6.100
Einbaurahmen 1-flammig



SCER 6.111
Einbaurahmen (rund) 1-flammig

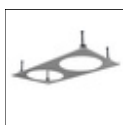

SCER 6.200
Einbaurahmen 2-flammig

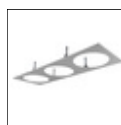

SCER 6.300
Einbaurahmen 3-flammig



SCER 6.310
Einbaurahmen (rund) 3-flammig



SCER 6.330
Einbau-Eckrahmen 3-flammig

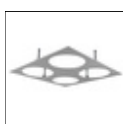

SCER 6.400
Einbaurahmen 4-flammig



ZB-OR DONGLE
Organic Response IR-Dongle-Set



ZB-OR GATEWAY
Organic Response IoT-Gateway Kaskadenserie



ZB-OR-R SENSOR
Organic Response Sensor für Einbaumontage